

2019 ₺

Fiyat Listesi  
Price List

# AYYAS

tarımsal sulama ekipmanları



15-02-2019

[www.ayassulama.com](http://www.ayassulama.com)

# INDEX

- 01-13 **Yağmurlama Sulama**  
Sprinkler Irrigation
- 
- 02-07 **Mandallı Yağmurlama Boru ve Ek Parçaları**  
Sprinkler Pipe With Latch and Accessories
- 10-13 **Sprinkler ve Ek Parçalar**  
Sprinklers and Accessories
- 
- 14-26 **Damla Sulama**  
Drip Irrigation
- 
- 15-16 **Yassı Damla Sulama Boruları**  
Flat Drip Irrigation Pipes
- 17 **Yuvarlak Damla Sulama Boruları**  
Round Drip Irrigation Pipes
- 18-26 **Damla Sulama Ek Parçaları**  
Drip Irrigation Accessories
- 
- 27-38 **Filtre Sistemleri**  
Filter Systems
- 
- 28-34 **Plastik Filtreler**  
Plastic Filters
- 35-36 **Metal Filtreler**  
Metal Filters
- 37 **Vanalar**  
Valves
- 38 **Filtre İç Takımları**  
Cartridge for Filter
- 
- 39-48 **Yeni Nesil Kaplinler**  
New Generation Compression Fittings
- 
- 49-52 **Priz Kolyeler**  
Clamp Saddles
- 
- 53 **Yükleme Detayları**  
Loading Details
-

# AYAS

tarımsal sulama ekipmanları

## Yağmurlama Sulama Sprinkler Irrigation



### YAĞMURLAMA BORULARI / Sprinkler Pipes

#### Turuncu Çizgili Seri



#### 5 Metre

Ürün Kodu Product Code	Ürün Çapı Product Diameter		Fiyat Price ₺
	mm	inch	
050-005-701	Ø 50	1 ½"	39,00
063-005-701	Ø 63	2"	49,50
075-005-701	Ø 75	2 ½"	65,00
090-005-701	Ø 90	3"	96,50
110-005-701	Ø 110	4"	183,00
125-005-701	Ø 125	4 ½"	247,00
140-005-701	Ø 140	5"	318,50
160-005-701	Ø 160	6"	405,00

#### 6 Metre

Ürün Kodu Product Code	Ürün Çapı Product Diameter		Fiyat Price ₺
	mm	inch	
050-005-702	Ø 50	1 ½"	45,50
063-005-702	Ø 63	2"	58,00
075-005-702	Ø 75	2 ½"	76,00
090-005-702	Ø 90	3"	112,00
110-005-702	Ø 110	4"	214,00
125-005-702	Ø 125	4 ½"	287,00
140-005-702	Ø 140	5"	370,00
160-005-702	Ø 160	6"	470,00

### YAĞMURLAMA BORULARI / Sprinkler Pipes

#### Mavi Çizgili Seri



+plus



#### 5 Metre

Ürün Kodu Product Code	Ürün Çapı Product Diameter		Fiyat Price ₺
	mm	inch	
050-006-601	Ø 50	1 ½"	55,00
063-006-601	Ø 63	2"	68,50
075-006-601	Ø 75	2 ½"	91,50
090-006-601	Ø 90	3"	130,00
110-006-601	Ø 110	4"	205,00
125-006-601	Ø 125	4 ½"	276,00
140-006-601	Ø 140	5"	357,00
160-006-601	Ø 160	6"	450,00

#### 6 Metre

Ürün Kodu Product Code	Ürün Çapı Product Diameter		Fiyat Price ₺
	mm	inch	
050-006-602	Ø 50	1 ½"	64,00
063-006-602	Ø 63	2"	80,50
075-006-602	Ø 75	2 ½"	107,00
090-006-602	Ø 90	3"	151,50
110-006-602	Ø 110	4"	240,00
125-006-602	Ø 125	4 ½"	321,50
140-006-602	Ø 140	5"	411,00
160-006-602	Ø 160	6"	520,00

## MANDALLI YAĞMURLAMA BORU VE EK PARÇALARI

# ERHAS®

Sprinkler Pipes With Latch and Accessories

### ABOT / Abot

Ürün Kodu Product Code	Ürün Çapı Product Diameter		Fiyat Price ₺
	mm	inch	
050-001-707	50	1 ½"	10,00
063-001-707	63	2"	12,00
075-001-707	75	2 ½"	21,50
090-001-707	90	3"	27,00
110-002-707	110	4"	36,00



### ABOT / Abot +plus

Ürün Kodu Product Code	Ürün Çapı Product Diameter		Fiyat Price ₺
	mm	inch	
050-001-607	50	1 ½"	11,50
063-001-607	63	2"	14,00
075-001-607	75	2 ½"	25,50
090-001-607	90	3"	31,50
110-002-607	110	4"	41,00



### REDÜKSİYON / Reduction

Ürün Kodu Product Code	Ürün Çapı Product Diameter		Ambalaj Miktarı Packing Quantity	Fiyat Price ₺
	mm	inch		
063-050-665	63 x 50	2" x 1 ½"	10	11,50
075-050-666	75 x 50	2 ½" x 1 ½"	10	17,00
075-063-667	75 x 63	2 ½" x 2"	10	18,50
090-050-668	90 x 50	3" x 1 ½"	10	23,00
090-063-669	90 x 63	3" x 2"	10	23,50
090-075-670	90 x 75	3" x 2 ½"	10	30,00
110-075-671	110 x 75	4" x 2 ½"	10	40,50
110-090-672	110 x 90	4" x 3"	10	48,00
125-075-673	125 x 75	4 ½" x 2 ½"	5	58,50
125-090-674	125 x 90	4 ½" x 3"	5	64,00
125-110-675	125 x 110	4 ½" x 4"	5	71,50
140-090-677	140 x 90	5" x 3"	5	84,00
140-110-678	140 x 110	5" x 4"	5	89,50
140-125-679	140 x 125	5" x 4 ½"	5	105,00
160-110-682	160 x 110	6" x 4"	5	106,00
160-125-683	160 x 125	6" x 4 ½"	5	113,00
160-140-684	160 x 140	6" x 5"	5	138,00



### MANDALLI KELEBEK HAT VANASI / Butterfly Line Valve With Clamp

Ürün Kodu Product Code	Ürün Çapı Product Diameter		Fiyat Price ₺
	mm	inch	
075-001-710	Ø 75	2 ½"	73,40
090-001-710	Ø 90	3"	90,50

**NEW**



### MANDALLI KELEBEK HAT VANASI / Butterfly Line Valve With Clamp

Ürün Kodu Product Code	Ürün Çapı Product Diameter		Fiyat Price ₺
	mm	inch	
075-000-710	Ø 75	2 ½"	95,00
090-000-710	Ø 90	3"	106,00
110-000-710	Ø 110	4"	220,00
125-000-710	Ø 125	4 ½"	270,00
140-000-710	Ø 140	5"	395,00
160-000-710	Ø 160	6"	700,00



### KELEPÇELİ KELEBEK HAT VANASI / Butterfly Line Valve With Latch

Ürün Kodu Product Code	Ürün Çapı Product Diameter		Fiyat Price ₺
	mm	inch	
075-003-710	Ø 75	2 ½"	128,00
090-003-710	Ø 90	3"	145,00
110-003-710	Ø 110	4"	285,00
125-003-710	Ø 125	4 ½"	340,00
140-003-710	Ø 140	5"	485,00
160-003-710	Ø 160	6"	715,00



### MANDALLI ARA GÜBRELEME HAT VANASI / Fertilizing Line Valve With Clamp

Ürün Kodu Product Code	Ürün Çapı Product Diameter		Fiyat Price ₺
	mm	inch	
110-002-710	Ø 110	4"	265,00
125-002-710	Ø 125	4 ½"	320,00
160-002-710	Ø 160	6"	720,00



### KELEPÇELİ ARA GÜBRELEME HAT VANASI / Fertilizing Line Valve With Latch

Ürün Kodu Product Code	Ürün Çapı Product Diameter		Fiyat Price ₺
	mm	inch	
110-004-710	Ø 110	4"	340,00
125-004-710	Ø 125	4 ½"	390,00
160-004-710	Ø 160	6"	730,00



**HAT VANASI / Spherical Line Valve**

Ürün Kodu Product Code	Ürün Çapı Product Diameter		Fiyat Price ₺
	mm	inch	
050-050-710	Ø 50	1 ½"	54,00
063-050-710	Ø 63	2"	61,00
075-050-710	Ø 75	2 ½"	71,50
090-050-710	Ø 90	3"	95,00
110-050-710	Ø 110	4"	148,00
125-050-710	Ø 125	4 ½"	264,00



**METAL DİŞLİ PLASTİK POMPA BAĞLANTISI (ERKEK) / Metal Threaded Plastic Pump Connection (Male)**

Ürün Kodu Product Code	Ürün Çapı Product Diameter		Ambalaj Miktarı Packing Quantity	Koli Tipi Box Type	Fiyat Price ₺
	mm	inch			
063-000-614	Ø 63	2"	60	B-1	21,00
075-000-614	Ø 75	2 ½"	30	B-1	26,50
090-000-614	Ø 90	3"	24	B-1	36,00
110-000-614	Ø 110	4"	12	B-1	48,00
125-000-614	Ø 125	4 ½"	8	B-1	70,00
140-000-614	Ø 140	5"	4	B-1	93,00
160-000-614	Ø 160	6"	4	B-1	102,00



Kaynak için uygun değildir. / Not proper for welding.

**METAL DİŞLİ PLASTİK POMPA BAĞLANTISI (DİŞİ) / Metal Threaded Plastic Pump Connection (Female)**

Ürün Kodu Product Code	Ürün Çapı Product Diameter		Ambalaj Miktarı Packing Quantity	Koli Tipi Box Type	Fiyat Price ₺
	mm	inch			
063-000-515	63	2"	80	B-1	15,00
075-000-515	75	2 ½"	36	B-1	21,00
090-000-515	90	3"	30	B-1	33,00
110-000-515	110	4"	18	B-1	43,00
125-000-515	125	4 ½"	8	B-1	67,00
140-000-515	140	5"	5	B-1	80,50
160-000-515	160	6"	5	B-1	93,00



Kaynak için uygun değildir. / Not proper for welding.

**CONTA / Gasket**

Ürün Kodu Product Code	Ürün Çapı Product Diameter		Fiyat Price ₺
	mm	inch	
050-000-509	50	1 ½"	0,85
063-000-509	63	2"	0,95
075-000-509	75	2 ½"	1,10
090-000-509	90	3"	1,60
110-000-509	110	4"	2,60
125-000-509	125	4 ½"	3,50
140-000-509	140	5"	6,00
160-000-509	160	6"	7,50



### PLASTİK DİŞLİ PLASTİK POMPA BAĞLANTISI (ERKEK) / Plastic Threaded Plastic Pump Connection (Male)

Ürün Kodu Product Code	Ürün Çapı Product Diameter		Ambalaj Miktarı Packing Quantity	Koli Tipi Box Type	Fiyat Price ₺
	mm	inch			
050-000-616	50	1 1/2"	100	B-1	9,00
063-000-616	63	2"	60	B-1	11,00
075-000-616	75	2 1/2"	36	B-1	14,00
090-000-616	90	3"	24	B-1	20,00



### PLASTİK DİŞLİ PLASTİK POMPA BAĞLANTISI (DİŞİ) / Plastic Threaded Plastic Pump Connection (Female)

Ürün Kodu Product Code	Ürün Çapı Product Diameter		Ambalaj Miktarı Packing Quantity	Koli Tipi Box Type	Fiyat Price ₺
	mm	inch			
050-000-517	50	1 1/2"	210	B-1	6,00
063-000-517	63	2"	120	B-1	9,00
075-000-517	75	2 1/2"	52	B-1	11,50
090-000-517	90	3"	36	B-1	15,00
110-000-517	110	4"	-	B-1	21,00



### DİRSEK / Elbow

Ürün Kodu Product Code	Ürün Çapı Product Diameter		Ambalaj Miktarı Packing Quantity	Fiyat Price ₺
	mm	inch		
050-000-608	50	1 1/2"	20	17,50
063-000-608	63	2"	20	20,50
075-000-608	75	2 1/2"	20	28,50
090-000-608	90	3"	10	42,00
110-000-608	110	4"	10	61,50
125-000-608	125	4 1/2"	10	95,00
140-000-608	140	5"	5	166,00
160-000-608	160	6"	4	171,00



### S / S

Ürün Kodu Product Code	Ürün Çapı Product Diameter		Ambalaj Miktarı Packing Quantity	Fiyat Price ₺
	mm	inch		
075-000-613	75	2 1/2"	3	78,50
090-000-613	90	3"	3	107,50
110-000-613	110	4"	3	130,00





## MANDALLI YAĞMURLAMA BORU VE EK PARÇALARI

Sprinkler Pipes With Latch and Accessories

**ASBİR®**

TE / Te



İSTAVROZ / Cross



Ürün Kodu Product Code	Ürün Çapı Product Diameter		Ambalaj Miktarı Packing Quantity	Fiyat Price ₺
	mm	inch		
050-050-621	50 x 50	1 1/2" x 1 1/2"	15	14,00
063-063-623	63 x 63	2" x 2"	15	18,00
075-050-624	75 x 50	2 1/2" x 1 1/2"	15	28,50
075-063-625	75 x 63	2 1/2" x 2"	15	30,50
075-075-626	75 x 75	2 1/2" x 2 1/2"	15	33,50
090-050-627	90 x 50	3" x 1 1/2"	15	48,00
090-063-628	90 x 63	3" x 2"	15	49,50
090-075-629	90 x 75	3" x 2 1/2"	15	52,50
090-090-630	90 x 90	3" x 3"	15	60,50
110-050-631	110 x 50	4" x 1 1/2"	12	65,50
110-063-631	110 x 63	4" x 2"	12	67,50
110-075-631	110 x 75	4" x 2 1/2"	12	69,50
110-090-632	110 x 90	4" x 3"	12	78,00
110-110-633	110 x 110	4" x 4"	12	83,00
125-050-634	125 x 50	4 1/2" x 1 1/2"	3	99,00
125-063-634	125 x 63	4 1/2" x 2"	3	101,00
125-075-634	125 x 75	4 1/2" x 2 1/2"	3	104,50
125-090-635	125 x 90	4 1/2" x 3"	3	112,50
125-110-636	125 x 110	4 1/2" x 4"	3	119,00
125-125-637	125 x 125	4 1/2" x 4 1/2"	3	131,50
140-075-638	140 x 75	5" x 2 1/2"	3	157,00
140-090-639	140 x 90	5" x 3"	3	165,00
140-110-640	140 x 110	5" x 4"	3	174,00
140-125-641	140 x 125	5" x 4 1/2"	3	183,00
140-140-642	140 x 140	5" x 5"	3	208,50
160-075-643	160 x 75	6" x 2 1/2"	3	169,00
160-090-644	160 x 90	6" x 3"	3	176,00
160-110-645	160 x 110	6" x 4"	3	182,00
160-125-646	160 x 125	6" x 4 1/2"	3	194,50
160-140-647	160 x 140	6" x 5"	3	215,50
160-160-648	160 x 160	6" x 6"	3	220,00

Ürün Kodu Product Code	Ürün Çapı Product Diameter		Ambalaj Miktarı Packing Quantity	Fiyat Price ₺
	mm	inch		
050-050-642	50 x 50	1 1/2" x 1 1/2"	15	17,00
063-063-644	63 x 63	2" x 2"	15	21,00
075-050-645	75 x 50	2 1/2" x 1 1/2"	15	33,00
075-063-646	75 x 63	2 1/2" x 2"	15	35,50
075-075-647	75 x 75	2 1/2" x 2 1/2"	15	42,50
090-050-648	90 x 50	3" x 1 1/2"	15	52,00
090-063-649	90 x 63	3" x 2"	15	55,50
090-075-650	90 x 75	3" x 2 1/2"	15	62,00
090-090-651	90 x 90	3" x 3"	15	77,00
110-050-652	110 x 50	4" x 1 1/2"	12	72,00
110-063-652	110 x 63	4" x 2"	12	74,00
110-075-652	110 x 75	4" x 2 1/2"	12	79,00
110-090-653	110 x 90	4" x 3"	12	94,50
110-110-654	110 x 110	4" x 4"	12	107,00
125-050-655	125 x 50	4 1/2" x 1 1/2"	3	104,50
125-063-655	125 x 63	4 1/2" x 2"	3	107,50
125-075-655	125 x 75	4 1/2" x 2 1/2"	3	115,50
125-090-656	125 x 90	4 1/2" x 3"	3	130,50
125-110-657	125 x 110	4 1/2" x 4"	3	144,00
125-125-658	125 x 125	4 1/2" x 4 1/2"	3	169,50
140-075-659	140 x 75	5" x 2 1/2"	3	168,00
140-090-660	140 x 90	5" x 3"	3	185,00
140-110-661	140 x 110	5" x 4"	3	199,00
140-125-662	140 x 125	5" x 4 1/2"	3	219,50
140-140-663	140 x 140	5" x 5"	3	273,00
160-075-664	160 x 75	6" x 2 1/2"	3	179,50
160-090-665	160 x 90	6" x 3"	3	195,50
160-110-666	160 x 110	6" x 4"	3	206,50
160-125-667	160 x 125	6" x 4 1/2"	3	231,00
160-140-668	160 x 140	6" x 5"	3	279,50
160-160-669	160 x 160	6" x 6"	3	284,00

### ERKEK BAŞLIK / Male Head

Ürün Kodu Product Code	Ürün Çapı Product Diameter		Ambalaj Miktarı Packing Quantity	Fiyat Price ₺
	mm	inch		
050-000-603	50	1 ½"	100	5,50
063-000-603	63	2"	100	6,00
075-000-603	75	2 ½"	75	10,00
090-000-603	90	3"	50	14,50
110-000-603	110	4"	40	23,00
125-000-603	125	4 ½"	20	37,50
140-000-603	140	5"	15	59,00
160-000-603	160	6"	10	60,50



### DİŞİ BAŞLIK / Female Head

Ürün Kodu Product Code	Ürün Çapı Product Diameter		Ambalaj Miktarı Packing Quantity	Fiyat Price ₺
	mm	inch		
050-000-504	50	1 ½"	100	3,50
063-000-504	63	2"	100	4,50
075-000-504	75	2 ½"	100	7,00
090-000-504	90	3"	75	13,50
110-000-504	110	4"	50	19,00
125-000-504	125	4 ½"	30	31,00
140-000-504	140	5"	20	54,00
160-000-504	160	6"	20	56,50



### ERKEK KÖRTAPA / Male End Cap

Ürün Kodu Product Code	Ürün Çapı Product Diameter		Ambalaj Miktarı Packing Quantity	Fiyat Price ₺
	mm	inch		
050-000-605	50	1 ½"	100	6,00
063-000-605	63	2"	100	7,00
075-000-605	75	2 ½"	75	12,00
090-000-605	90	3"	50	16,00
110-000-605	110	4"	40	24,50
125-000-605	125	4 ½"	20	42,50
140-000-605	140	5"	15	64,00
160-000-605	160	6"	10	68,50



### DİŞİ KÖRTAPA / Female End Cap

Ürün Kodu Product Code	Ürün Çapı Product Diameter		Ambalaj Miktarı Packing Quantity	Fiyat Price ₺
	mm	inch		
050-000-506	50	1 ½"	100	4,00
063-000-506	63	2"	100	5,00
075-000-506	75	2 ½"	100	7,50
090-000-506	90	3"	75	14,00
110-000-506	110	4"	50	20,00
125-000-506	125	4 ½"	30	35,00
140-000-506	140	5"	20	55,00
160-000-506	160	6"	20	61,50



# AYAS

tarımsal sulama ekipmanları

## Sprinkler Sprinklers



//

Erhas Tarımsal Sulama Başlıkları farklı debilerde değiştirilebilir memeler takılabilecek şekilde UV ışınlarına karşı son derece dayanıklı plastik malzemeden üretilmiştir. Ürünlerimizde kullanılan uygun gerginliğe ayarlanabilir paslanmaz çelik yay sayesinde her basınç değerinde düşük ve orta hızda rahatlıkla çalışabilir. Kolay ve stabil dönüşü sağlamak için teflon yatakla desteklenmiştir. Yivli püskürtme yoluyla suyu döndürerek toz şeklinde dağıtır ve su yayma pimi yardımıyla açıklık bırakmadan sulamanın sağlıklı bir şekilde yapılmasını sağlar.

**Not:** Kataloğumuzdaki veriler rüzgârsız ortamda yerden 65 cm yükseklikte ayarlanabilir basınçlı suda kendi teknik elemanlarımız tarafından elde edilmiştir.

Erhas Agricultural Irrigation Sprinklers are produced of UV resistant strong plastic material with changeable nozzles in different flow rates. Thanks to the hardness adjustable stainless steel springs used in the manufacture of Asbir Sprinklers, it can work at all pressure rates, slow and fast circle speed easily. In order to perform easy and continuous rotation, it is provided with teflon bearing. With the advantage of distribution sections inside nozzle grooves and water spreading pins, it sprinkles the water as cyclone shape and in very small particles. Therefore it can irrigate the whole area without any non-irrigated space.

**Note:** Mentioned data in our catalog are obtained by our technical staff with the adjustable pressured water by using 65 cm riser pipes from the ground level.

//

### SPRİNK - 1610 S / Sprink - 1610 S



Teknik Özellikler - Technical Specifications						
Meme Çapı Nozzle Diameter	2 Bar		2,5 Bar		3 Bar	
	Debi Flow	Atış Mesafesi Throw Range	Debi Flow	Atış Mesafesi Throw Range	Debi Flow	Atış Mesafesi Throw Range
	lt/h	m - ( r )	lt/h	m - ( r )	lt/h	m - ( r )
4,0 - 5,0 mm	2110	15,00	2300	16,00	2615	16,50
4,0 - 6,0 mm	2375	15,50	2760	16,50	3140	17,00
3,5 - 4,5 mm	1890	13,00	2070	13,50	2255	14,50
3,5 - 5,5 mm	2190	15,50	2390	16,00	2710	16,50

Ürün Kodu Product Code	Meme Çapları (mm) Nozzle Diameter (mm)				Bağlantı Çapı Diameter		Ambalaj Miktarı Packing Quantity		Koli Tipi Box Type	Fiyat Price
	montajlı / mounted		yedek / spare		mm	inch	poşet / bag	koli / box		₺
	sağ / right	sol / left	sağ / right	sol / left						
025-000-015	4,0	5,0	-	6,0	25	¾	1	80	B-1	
			3,5	4,5	25	¾	1	80	B-1	
			3,5	5,5	25	¾	1	80	B-1	

### SPRİNK - 1610 SK / Sprink - 1610 SK



Teknik Özellikler - Technical Specifications						
Meme Çapı Nozzle Diameter	2 Bar		2,5 Bar		3 Bar	
	Debi Flow	Atış Mesafesi Throw Range	Debi Flow	Atış Mesafesi Throw Range	Debi Flow	Atış Mesafesi Throw Range
	lt/h	m - ( r )	lt/h	m - ( r )	lt/h	m - ( r )
4,0 - 5,0 mm	2110	15,00	2300	16,00	2615	16,50
4,0 - 6,0 mm	2375	15,50	2760	16,50	3140	17,00
3,5 - 4,5 mm	1890	13,00	2070	13,50	2255	14,50
3,5 - 6,0 mm	2200	15,50	2560	16,00	2915	17,00
2,3 - 3,8 mm	1050	12,00	1200	12,50	1300	12,80

Ürün Kodu Product Code	Meme Çapları (mm) Nozzle Diameter (mm)				Bağlantı Çapı Diameter		Ambalaj Miktarı Packing Quantity		Koli Tipi Box Type	Fiyat Price
	montajlı / mounted		yedek / spare		mm	inch	poşet / bag	koli / box		₺
	sağ / right	sol / left	sağ / right	sol / left						
025-000-016-01	4,0	5,0	3,5	4,5	25	¾	1	60	B-1	
			-	6,0						
025-000-016-02	2,3	3,8	-	4,5	25	¾	1	60	B-1	
			-	6,0						
			-	5,0						

**SPRINK - 1615 / Sprink - 1615**

Teknik Özellikler - Technical Specifications						
Meme Çapı Nozzle Diameter	2 Bar		2,5 Bar		3 Bar	
	Debi Flow	Atış Mesafesi Throw Range	Debi Flow	Atış Mesafesi Throw Range	Debi Flow	Atış Mesafesi Throw Range
	lt/h	m - ( r )	lt/h	m - ( r )	lt/h	m - ( r )
1,8 - 2,3 mm	510	11,00	580	11,00	600	11,00
1,8 - 2,8 mm	690	11,00	760	11,00	820	11,00
1,8 - 3,2 mm	820	11,50	900	12,00	980	12,00
2,5 - 3,5 mm	1060	12,25	1160	12,50	1240	12,75



Ürün Kodu Product Code	Meme Çapları (mm) Nozzle Diameter (mm)				Bağlantı Çapı Diameter		Ambalaj Miktarı Packing Quantity		Koli Tipi Box Type	Fiyat Price ₺
	montajlı / mounted		yedek / spare		mm	inch	poşet / bag	koli / box		
	sağ / right	sol / left	sağ / right	sol / left						
025-000-013	2,5	3,5	2,1	3,2	20	½	1	175	B-1	8,50
			1,8	2,8						

**SPRINK - 1615 K / Sprink - 1610 K**

Teknik Özellikler - Technical Specifications						
Meme Çapı Nozzle Diameter	2 Bar		2,5 Bar		3 Bar	
	Debi Flow	Atış Mesafesi Throw Range	Debi Flow	Atış Mesafesi Throw Range	Debi Flow	Atış Mesafesi Throw Range
	lt/h	m - ( r )	lt/h	m - ( r )	lt/h	m - ( r )
1,8 - 2,3 mm	510	11,00	580	11,00	600	11,00
1,8 - 2,8 mm	690	11,00	760	11,00	820	11,00
1,8 - 3,2 mm	820	11,50	900	12,00	980	12,00
2,5 - 3,5 mm	1060	12,25	1160	12,50	1240	12,75



Ürün Kodu Product Code	Meme Çapları (mm) Nozzle Diameter (mm)				Bağlantı Çapı Diameter		Ambalaj Miktarı Packing Quantity		Koli Tipi Box Type	Fiyat Price ₺
	montajlı / mounted		yedek / spare		mm	inch	poşet / bag	koli / box		
	sağ / right	sol / left	sağ / right	sol / left						
025-000-014	2,5 K	3,5	2,1	3,2	20	½	1	150	B-1	8,50
			1,8	2,8						

### UZATMA BORUSU - PP / Riser Pipe PP

Ürün Kodu Product Code	Renk Color	Uzunluk Lenght	Bağlantı Çapı Diameter			Ambalaj Miktarı Packing Quantity	Çuval Tipi Sack Type	Fiyat ₺
			cm	mm	inch			
032-032-125	Turuncu	25 MxM	32x32	1"x1"	100	S-2	4,40	
032-032-225	Turuncu	25 MxF	32x32	1"x1"	100	S-2	4,40	
032-032-135	Turuncu	35 MxM	32x32	1"x1"	100	S-2	6,20	
032-032-235	Turuncu	35 MxF	32x32	1"x1"	100	S-2	6,20	
032-032-150	Turuncu	50 MxM	32x32	1"x1"	100	S-3	8,80	
032-032-250	Turuncu	50 MxF	32x32	1"x1"	100	S-3	8,80	



### UZATMA BORUSU - PP (EKO) / Riser Pipe PP (ECO)

Ürün Kodu Product Code	Renk Color	Uzunluk Lenght	Bağlantı Çapı Diameter			Ambalaj Miktarı Packing Quantity	Çuval Tipi Sack Type	Fiyat ₺
			cm	mm	inch			
032-032-325	Siyah	25 MxM	32x32	1"x1"	100	S-2	2,80	
032-032-425	Siyah	25 MxF	32x32	1"x1"	100	S-2	2,80	
032-032-335	Siyah	35 MxM	32x32	1"x1"	100	S-2	3,90	
032-032-435	Siyah	35 MxF	32x32	1"x1"	100	S-2	3,90	
032-032-350	Siyah	50 MxM	32x32	1"x1"	100	S-3	5,50	
032-032-450	Siyah	50 MxF	32x32	1"x1"	100	S-3	5,50	



### UZATMA BORUSU - PVC / Riser Pipe PVC

Ürün Kodu Product Code	Uzunluk Lenght	Bağlantı Çapı Diameter			Ambalaj Miktarı Packing Quantity	Çuval Tipi Sack Type	Fiyat ₺
		cm	mm	inch			
032-132-025	25	32x32	1"x1"	100	-	2,00	
032-132-033	33	32x32	1"x1"	100	-	2,64	
032-132-050	50	32x32	1"x1"	100	-	4,00	
032-132-060	60	32x32	1"x1"	100	-	4,80	
032-132-100	100	32x32	1"x1"	100	-	8,00	
032-132-125	125	32x32	1"x1"	40	-	10,00	
032-132-150	150	32x32	1"x1"	40	-	12,00	
032-132-200	200	32x32	1"x1"	40	-	16,00	



### UZATMA BORUSU MAVİ - PVC / Riser Pipe Blue - PVC

Ürün Kodu Product Code	Uzunluk Lenght	Bağlantı Çapı Diameter			Ambalaj Miktarı Packing Quantity	Çuval Tipi Sack Type	Fiyat ₺
		cm	mm	inch			
032-232-025	25	32x32	1"x1"	100	-	1,64	
032-232-033	33	32x32	1"x1"	100	-	2,17	
032-232-050	50	32x32	1"x1"	100	-	3,28	
032-232-060	60	32x32	1"x1"	100	-	3,93	
032-232-100	100	32x32	1"x1"	100	-	6,55	
032-232-125	125	32x32	1"x1"	40	-	8,19	
032-232-150	150	32x32	1"x1"	40	-	9,83	
032-232-200	200	32x32	1"x1"	40	-	13,10	



**KÜRESEL VANA / Spherical Valve**

Ürün Kodu Product Code	Bağlantı Çapı Diameter		Ambalaj Miktarı Packing Quantity		Çuval Tipi Sack Type	Fiyat ₺ Price
	mm	inch	çuval / sack			
032-032-004	32	1"	100		S-4	3,25



**NİPEL / Nipple**

Ürün Kodu Product Code	Bağlantı Çapı Diameter		Ambalaj Miktarı Packing Quantity		Çuval Tipi Sack Type	Fiyat ₺ Price
	mm	inch	poşet / bag	koli / box		
032-032-003	32x32	1"x1"	150	450	B-1	1,30



**MANŞON / Sleeve**

Ürün Kodu Product Code	Bağlantı Çapı Diameter		Ambalaj Miktarı Packing Quantity		Çuval Tipi Sack Type	Fiyat ₺ Price
	mm	inch	poşet / bag	koli / box		
032-020-001	32x20	1"x1/2"	150	450	B-1	0,75
032-025-002	32x25	1"x3/4"	150	450	B-1	0,75
032-032-005	32x32	1"x1"	150	450	B-1	1,50



**ADAPTÖR / Adaptor**

Ürün Kodu Product Code	Bağlantı Çapı Diameter		Ambalaj Miktarı Packing Quantity		Çuval Tipi Sack Type	Fiyat ₺ Price
	mm	inch	poşet / bag	koli / box		
032-025-001	32x25	1"x3/4"	150	450	B-1	0,85
040-032-006	40x32	1 1/2"x1"	150	450	B-1	0,85



**MİNİ SPRINK VIDALI MANŞON / Mini Sprink Sleeve With Screw**

Ürün Kodu Product Code	Bağlantı Çapı Diameter		Ambalaj Miktarı Packing Quantity		Koli Tipi Box Type	Fiyat ₺ Price
	mm	inch	Poşet	Koli		
020-000-007	20 x 20	1/2" x 1/2"	100	500	B-1	1,30
025-000-007	25 x 25	3/4" x 3/4"	100	500	B-1	1,50



**ABOT ÜSTÜ İSTAVROZ / Abot Cross**

Ürün Kodu Product Code	Bağlantı Çapı Diameter		Ambalaj Miktarı Packing Quantity		Koli Tipi Box Type	Fiyat ₺ Price
	mm	inch	Poşet	Koli		
A - 020-000-008	32x20x20x20	1"x1/2"x1/2"x1/2"	100	400	B-2	2,20
B - 020-000-009	32x25x20x20	1"x3/4"x1/2"x1/2"	100	400	B-2	1,90
C - 020-000-011	32x32x20x20	1"x1"x1/2"x1/2"	100	300	B-2	2,20
C - 025-000-011	32x32x25x25	1"x1"x3/4"x3/4"	100	300	B-2	2,30



# AYAS

tarımsal sulama ekipmanları

## Damla Sulama

### Drip Irrigation







**Ø 17 mm YASSI DAMLA SULAMA BORULARI / Ø 17 mm Flat Drip Irrigation Pipes (Tapes)**

Ürün Kodu Product Code	Ürün Kodu Product Code	Ürün Kodu Product Code	Dış Çap Diameter	Et Kalınlığı Wall Thickness	Debi Flow	Damlatıcı Aralığı Dripper Spaces	Rulo Uzunluğu Roll Length	Fiyat Price			
1,0 L/h	1,6 L/h	2,2 L/h	mm	mil / mm	L/h	cm	m	₺			
017-06-10-010	017-06-16-010	017-06-22-010	17	6 mil 0,150 mm	1,0	10	2500	0,3885			
017-06-10-015	017-06-16-015	017-06-22-015				15		0,3391			
017-06-10-020	017-06-16-020	017-06-22-020				20		0,3105			
017-06-10-025	017-06-16-025	017-06-22-025				25		0,2989			
017-06-10-030	017-06-16-030	017-06-22-030				30		0,2911			
017-06-10-040	017-06-16-040	017-06-22-040				40		0,2814			
017-06-10-050	017-06-16-050	017-06-22-050				50		0,2755			
017-08-10-010	017-08-16-010	017-08-22-010				10		8 mil 0,200 mm	1,6	10	0,4427
017-08-10-015	017-08-16-015	017-08-22-015				15				0,3935	
017-08-10-020	017-08-16-020	017-08-22-020				20				0,3641	
017-08-10-025	017-08-16-025	017-08-22-025		25	0,3532						
017-08-10-030	017-08-16-030	017-08-22-030		30	0,3460						
017-08-10-040	017-08-16-040	017-08-22-040		40	0,3369						
017-08-10-050	017-08-16-050	017-08-22-050		50	0,3315						
017-10-10-010	017-10-16-010	017-10-22-010		10	10 mil 0,250 mm	2,2	10	0,5232			
017-10-10-015	017-10-16-015	017-10-22-015		15			0,4708				
017-10-10-020	017-10-16-020	017-10-22-020		20			0,4387				
017-10-10-025	017-10-16-025	017-10-22-025		25			0,4278				
017-10-10-030	017-10-16-030	017-10-22-030		30			0,4206				
017-10-10-040	017-10-16-040	017-10-22-040		40			0,4115				
017-10-10-050	017-10-16-050	017-10-22-050		50	0,4061						

**Ø 22 mm YASSI DAMLA SULAMA BORULARI / Ø 22 mm Flat Drip Irrigation Pipes (Tapes)**

Ürün Kodu Product Code	Ürün Kodu Product Code	Ürün Kodu Product Code	Dış Çap Diameter	Et Kalınlığı Wall Thickness	Debi Flow	Damlatıcı Aralığı Dripper Spaces	Rulo Uzunluğu Roll Length	Fiyat Price			
1,0 L/h	1,6 L/h	2,2 L/h	mm	mil / mm	L/h	cm	m	₺			
022-08-10-010	022-08-16-010	022-08-22-010	22	8 mil 0,200 mm	1,0	10	1500	0,5440			
022-08-10-015	022-08-16-015	022-08-22-015				15		0,4910			
022-08-10-020	022-08-16-020	022-08-22-020				20		0,4582			
022-08-10-025	022-08-16-025	022-08-22-025				25		0,4474			
022-08-10-030	022-08-16-030	022-08-22-030				30		0,4401			
022-08-10-040	022-08-16-040	022-08-22-040				40		0,4311			
022-08-10-050	022-08-16-050	022-08-22-050				50		0,4257			
022-10-10-010	022-10-16-010	022-10-22-010				10		10 mil 0,250 mm	1,6	10	0,6503
022-10-10-015	022-10-16-015	022-10-22-015				15				0,5931	
022-10-10-020	022-10-16-020	022-10-22-020				20				0,5567	
022-10-10-025	022-10-16-025	022-10-22-025		25	0,5459						
022-10-10-030	022-10-16-030	022-10-22-030		30	0,5386						
022-10-10-040	022-10-16-040	022-10-22-040		40	0,5296						
022-10-10-050	022-10-16-050	022-10-22-050		50	0,5242						
022-12-10-010	022-12-16-010	022-12-22-010		10	12 mil 0,300 mm	2,2	10	0,7550			
022-12-10-015	022-12-16-015	022-12-22-015		15			0,6937				
022-12-10-020	022-12-16-020	022-12-22-020		20			0,6537				
022-12-10-025	022-12-16-025	022-12-22-025		25			0,6429				
022-12-10-030	022-12-16-030	022-12-22-030		30			0,6357				
022-12-10-040	022-12-16-040	022-12-22-040		40			0,6266				
022-12-10-050	022-12-16-050	022-12-22-050		50	0,6212						



### Ø 25 mm YASSI DAMLA SULAMA BORULARI / Ø 25 mm Flat Drip Irrigation Pipes (Tapes)

Ürün Kodu Product Code	Ürün Kodu Product Code	Ürün Kodu Product Code	Dış Çap Diameter	Et Kalınlığı Wall Thickness	Debi Flow	Damlatıcı Aralığı Dripper Spaces	Rulo Uzunluğu Roll Length	Fiyat Price		
1,0 L/h	1,6 L/h	2,2 L/h	mm	mil / mm	L/h	cm	m	₺		
025-10-10-010	025-10-16-010	025-10-22-010	25	10 mil 0,250 mm	1,0/1,6/2,2	10	1100	0,7258		
025-10-10-015	025-10-16-015	025-10-22-015				15		0,6658		
025-10-10-020	025-10-16-020	025-10-22-020				20		0,6269		
025-10-10-025	025-10-16-025	025-10-22-025				25		0,6160		
025-10-10-030	025-10-16-030	025-10-22-030				30		0,6088		
025-10-10-040	025-10-16-040	025-10-22-040				40		0,5997		
025-10-10-050	025-10-16-050	025-10-22-050				50		0,5943		
025-12-10-010	025-12-16-010	025-12-22-010				12 mil 0,300 mm		10	1000	0,9052
025-12-10-015	025-12-16-015	025-12-22-015						15		0,8358
025-12-10-020	025-12-16-020	025-12-22-020						20		0,7897
025-12-10-025	025-12-16-025	025-12-22-025		25			0,7781			
025-12-10-030	025-12-16-030	025-12-22-030		30			0,7703			
025-12-10-040	025-12-16-040	025-12-22-040		40			0,7605			
025-12-10-050	025-12-16-050	025-12-22-050		50			0,7547			
025-16-10-010	025-16-16-010	025-16-22-010		16 mil 0,400 mm			10	900		1,0826
025-16-10-015	025-16-16-015	025-16-22-015					15			1,0084
025-16-10-020	025-16-16-020	025-16-22-020					20			0,9573
025-16-10-025	025-16-16-025	025-16-22-025				25	0,9464			
025-16-10-030	025-16-16-030	025-16-22-030				30	0,9392			
025-16-10-040	025-16-16-040	025-16-22-040				40	0,9301			
025-16-10-050	025-16-16-050	025-16-22-050				50	0,9247			

### Ø 28 mm YASSI DAMLA SULAMA BORULARI / Ø 28 mm Flat Drip Irrigation Pipes (Tapes)

Ürün Kodu Product Code	Ürün Kodu Product Code	Ürün Kodu Product Code	Dış Çap Diameter	Et Kalınlığı Wall Thickness	Debi Flow	Damlatıcı Aralığı Dripper Spaces	Rulo Uzunluğu Roll Length	Fiyat Price		
1,0 L/h	1,6 L/h	2,2 L/h	mm	mil / mm	L/h	cm	m	₺		
028-14-10-010	028-14-16-010	028-14-22-010	28	14 mil 0,350 mm	1,0/1,6/2,2	10	800	1,1935		
028-14-10-015	028-14-16-015	028-14-22-015				15		1,1115		
028-14-10-020	028-14-16-020	028-14-22-020				20		1,0550		
028-14-10-025	028-14-16-025	028-14-22-025				25		1,0430		
028-14-10-030	028-14-16-030	028-14-22-030				30		1,0349		
028-14-10-040	028-14-16-040	028-14-22-040				40		1,0248		
028-14-10-050	028-14-16-050	028-14-22-050				50		1,0187		
028-16-10-010	028-16-16-010	028-16-22-010				16 mil 0,400 mm		10	750	1,3424
028-16-10-015	028-16-16-015	028-16-22-015						15		1,2545
028-16-10-020	028-16-16-020	028-16-22-020						20		1,1929
028-16-10-025	028-16-16-025	028-16-22-025		25			1,1809			
028-16-10-030	028-16-16-030	028-16-22-030		30			1,1728			
028-16-10-040	028-16-16-040	028-16-22-040		40			1,1627			
028-16-10-050	028-16-16-050	028-16-22-050		50			1,1566			

**DRİPLİ DAMLA SULAMA BORUSU (400 METRE / RULO) / Internal Dripper Pipe (400 Meters / Roll)**



Ürün Kodu Product Code	Ürün Kodu Product Code	Ürün Kodu Product Code	Dış Çap Diameter	Et Kalınlığı Wall Thickness	Debi Flow	Damlaticı Aralığı Dripper Spaces	Fiyat Price
2,0 L/h	4,0 L/h	8,0 L/h	mm	mil / mm	L/h	cm	₺
016-08-20-020	016-08-40-020	016-08-80-020	16	0,8	2,0	20	275,00
016-08-20-025	016-08-40-025	016-08-80-025				25	268,00
016-08-20-033	016-08-40-033	016-08-80-033				33	261,50
016-08-20-040	016-08-40-040	016-08-80-040				40	256,50
016-08-20-050	016-08-40-050	016-08-80-050				50	252,00
016-09-20-020	016-09-40-020	016-09-80-020		0,9		20	288,00
016-09-20-025	016-09-40-025	016-09-80-025				25	282,00
016-09-20-033	016-09-40-033	016-09-80-033				33	275,00
016-09-20-040	016-09-40-040	016-09-80-040				40	270,00
016-09-20-050	016-09-40-050	016-09-80-050				50	265,00
016-10-20-020	016-10-40-020	016-10-80-020	1,0	20	302,00		
016-10-20-025	016-10-40-025	016-10-80-025		25	296,00		
016-10-20-033	016-10-40-033	016-10-80-033		33	288,00		
016-10-20-040	016-10-40-040	016-10-80-040		40	283,00		
016-10-20-050	016-10-40-050	016-10-80-050		50	278,00		
020-10-20-020	020-10-40-020	020-10-80-020	20	1,0	20	370,00	
020-10-20-025	020-10-40-025	020-10-80-025			25	355,00	
020-10-20-033	020-10-40-033	020-10-80-033			33	340,00	
020-10-20-040	020-10-40-040	020-10-80-040			40	326,00	
020-10-20-050	020-10-40-050	020-10-80-050			50	313,00	
020-12-20-020	020-12-40-020	020-12-80-020		1,2	20	410,00	
020-12-20-025	020-12-40-025	020-12-80-025			25	393,00	
020-12-20-033	020-12-40-033	020-12-80-033			33	376,00	
020-12-20-040	020-12-40-040	020-12-80-040			40	360,00	
020-12-20-050	020-12-40-050	020-12-80-050			50	345,00	

**DIŞTAN DAMLATICI TAKILAN DAMLA SULAMA BORUSU / Drip Irrigation Pipe For External Drippers**



Ürün Kodu Product Code	Dış Çap Diameter	Et Kalınlığı Wall Thickness	Rulo Uzunluğu Roll Length	Fiyat Price
	mm	mm	m	₺
016-08-00-080	16	0,8	400	245,00
016-09-00-090	16	0,9	400	258,00
016-10-00-100	16	1,0	400	270,00
020-10-00-100	20	1,0	300	275,00
020-12-00-120	20	1,2	300	288,00

#### KURT AĞIZLI MİNİ VANALAR / Dovetail Mini Valves

Ürün Kodu Product Code	Bağlantı Çapı Diameter	Ambalaj Miktarı Packing Quantity		Koli Tipi Box Type	Koli Ağırlığı Box Weight	Fiyat ₺ Price
		poşet - bag	koli - box			
100-16-08-001	16 x 16	125	625	B-1	10,656	1,10
100-20-08-002	20 x 16	125	500	B-1	-	1,40
100-20-08-003	20 x 20	125	500	B-1	-	1,50



#### KURT AĞIZLI CONTA ÇIKIŞLI MİNİ VANALAR / Dovetail Mini Valves With Gasket Outlet

Ürün Kodu Product Code	Bağlantı Çapı Diameter	Ambalaj Miktarı Packing Quantity		Koli Tipi Box Type	Koli Ağırlığı Box Weight	Fiyat ₺ Price
		poşet - bag	koli - box			
100-16-09-001	16 x 16	125	625	B-1	10,825	1,10
100-20-09-002	20 x 16	125	500	B-1	-	1,40
100-20-09-003	20 x 20	125	500	B-1	-	1,50



#### CONTA ÇIKIŞLI TAPE MİNİ VANALAR / Tape Mini Valves With Gasket Outlet

Ürün Kodu Product Code	Bağlantı Çapı Diameter	Ambalaj Miktarı Packing Quantity		Koli Tipi Box Type	Koli Ağırlığı Box Weight	Fiyat ₺ Price
		poşet - bag	koli - box			
100-16-10-001	16 x 17	100	500	B-1	12,142	1,50
100-20-10-002	20 x 17	100	400	B-1	-	1,80
100-20-10-003	20 x 22	100	400	B-1	-	1,90



#### KURT AĞIZLI TAPE MİNİ VANALAR / Dovetail Tape Mini Valves

Ürün Kodu Product Code	Bağlantı Çapı Diameter	Ambalaj Miktarı Packing Quantity		Koli Tipi Box Type	Koli Ağırlığı Box Weight	Fiyat ₺ Price
		poşet - bag	koli - box			
100-16-11-001	16 x 17	100	500	B-1	11,894	1,50
100-20-11-002	20 x 17	100	400	B-1	-	1,80
100-20-11-003	20 x 22	100	400	B-1	-	1,90



#### ERKEK DİŞLİ KURT AĞIZLI MİNİ VANALAR / Male Screwed Dovetail Mini Valves

Ürün Kodu Product Code	Bağlantı Çapı Diameter	Ambalaj Miktarı Packing Quantity		Koli Tipi Box Type	Koli Ağırlığı Box Weight	Fiyat ₺ Price
		poşet - bag	koli - box			
100-16-12-001	1/2 x 16	100	500	B-1	10,517	1,40
100-16-12-002	3/4 x 16	100	500	B-1	11,500	1,50
100-20-12-003	1/2 x 20	100	400	B-1	-	1,60
100-20-12-004	3/4 x 20	100	400	B-1	-	1,70



**ERKEK DİŞLİ TAPE MİNİ VANALAR** / Male Screwed Tape Mini Valves

Ürün Kodu Product Code	Bağlantı Çapı Diameter		Ambalaj Miktarı Packing Quantity		Koli Tipi Box Type	Koli Ağırlığı Box Weight	Fiyat ₺ Price
	mm		poşet - bag	koli - box			
100-17-13-001	1/2 x 17		80	400	B-1	11,385	1,60
100-17-13-002	3/4 x 17		80	400	B-1	12,030	1,90
100-22-13-003	1/2 x 22		-	-	B-1	-	2,20
100-22-13-004	3/4 x 22		-	-	B-1	-	2,30



**TAPE MİNİ VANALAR** / Tape Mini Valves

Ürün Kodu Product Code	Bağlantı Çapı Diameter		Ambalaj Miktarı Packing Quantity		Koli Tipi Box Type	Koli Ağırlığı Box Weight	Fiyat ₺ Price
	mm		poşet - bag	koli - box			
100-17-14-001	17 x 17		80	400	B-1	12,425	1,70
100-22-14-001	22 x 22		80	320	B-1	-	2,30



**ERKEK DİŞLİ CONTA ÇIKIŞLI MİNİ VANALAR** / Male Screwed Mini Valves With Gasket Outlet

Ürün Kodu Product Code	Bağlantı Çapı Diameter		Ambalaj Miktarı Packing Quantity		Koli Tipi Box Type	Koli Ağırlığı Box Weight	Fiyat ₺ Price
	mm		poşet - bag	koli - box			
100-16-15-001	1/2 x 16		100	400	B-1	10,665	1,40
100-16-15-002	3/4 x 16		100	400	B-1	11,690	1,50



**ERKEK DİŞLİ YÜZÜKLÜ MİNİ VANALAR** / Male Screwed Mini Valves With Ring

Ürün Kodu Product Code	Bağlantı Çapı Diameter		Ambalaj Miktarı Packing Quantity		Koli Tipi Box Type	Koli Ağırlığı Box Weight	Fiyat ₺ Price
	mm		poşet - bag	koli - box			
100-17-16-001	1/2 x 17		90	450	B-1	10,790	1,50
100-17-16-002	3/4 x 17		90	450	B-1	11,545	1,60
100-22-16-003	1/2 x 22		90	360	B-1	-	2,20
100-22-16-004	3/4 x 22		90	360	B-1	-	2,30
100-25-16-005	1/2 x 25		-	-	B-1	-	2,60
100-25-16-006	3/4 x 25		-	-	B-1	-	2,70
100-28-16-007	1/2 x 28		-	-	B-1	-	2,80
100-28-16-008	3/4 x 28		-	-	B-1	-	2,90



**ERKEK DİŞLİ MİNİ VANALAR** / Male Screwed Mini Valves

Ürün Kodu Product Code	Bağlantı Çapı Diameter		Ambalaj Miktarı Packing Quantity		Koli Tipi Box Type	Koli Ağırlığı Box Weight	Fiyat ₺ Price
	mm		poşet - bag	koli - box			
100-16-17-001	1/2 x 1/2		80	320	B-1	10,125	1,50
100-16-17-002	3/4 x 3/4		80	320	B-1	11,585	1,80



### CONTA ÇIKIŞLI YÜZÜKLÜ MİNİ VANALAR / Gasket Outlet Mini Valves With Ring

Ürün Kodu Product Code	Bağlantı Çapı Diameter	Ambalaj Miktarı Packing Quantity		Koli Tipi Box Type	Koli Ağırlığı Box Weight	Fiyat Price
		poşet - bag	koli - box			
100-16-18-001	16 x 17	100	500	B-1	10,025	1,30
100-16-18-002	16 x 22	100	400	B-1	-	1,60
100-20-18-003	20 x 22	100	400	B-1	-	1,80
100-20-18-004	20 x 25	-	-	B-1	-	2,50
100-25-18-005	25 x 25	-	-	B-1	-	2,60
100-25-18-006	25 x 28	-	-	B-1	-	2,80



### KURT AĞIZLI YÜZÜKLÜ MİNİ VANALAR / Dovetail Mini Valves With Ring

Ürün Kodu Product Code	Bağlantı Çapı Diameter	Ambalaj Miktarı Packing Quantity		Koli Tipi Box Type	Koli Ağırlığı Box Weight	Fiyat Price
		poşet - bag	koli - box			
100-16-19-001	16 x 17	100	500	B-1	9,900	1,30
100-16-19-002	16 x 22	100	400	B-1	-	1,60
100-20-19-003	20 x 22	100	400	B-1	-	1,80



### TAPE YÜZÜKLÜ MİNİ VANALAR / Tape Mini Valves With Ring

Ürün Kodu Product Code	Bağlantı Çapı Diameter	Ambalaj Miktarı Packing Quantity		Koli Tipi Box Type	Koli Ağırlığı Box Weight	Fiyat Price
		poşet - bag	koli - box			
100-17-20-001	17 x 17	90	450	B-1	11,980	1,60
100-17-20-002	17 x 22	90	360	B-1	-	2,00
100-22-20-003	22 x 22	90	360	B-1	-	2,20



### YÜZÜKLÜ MİNİ VANALAR / Mini Valves With Ring

Ürün Kodu Product Code	Bağlantı Çapı Diameter	Ambalaj Miktarı Packing Quantity		Koli Tipi Box Type	Koli Ağırlığı Box Weight	Fiyat Price
		poşet - bag	koli - box			
100-17-21-001	17 x 17	100	500	B-1	11,085	1,30
100-22-21-002	22 x 22	100	300	B-1	-	1,80
100-25-21-003	25 x 25	-	-	B-1	-	2,60
100-28-21-004	28 x 28	-	-	B-1	-	2,80



**YÜZÜKLÜ ERKEK DİŞLİ TE VANA** / Male Screwed Te Valve With Ring

Ürün Kodu Product Code	Bağlantı Çapı Diameter	Ambalaj Miktarı Packing Quantity		Koli Tipi Box Type	Koli Ağırlığı Box Weight	Fiyat Price
		poşet - bag	koli - box			
100-17-12-017	17 x ½ x 17	-	-	-	-	3,33
100-22-12-022	22 x ½ x 22	-	-	-	-	3,57
100-25-12-025	25 x ½ x 25	-	-	-	-	3,85



**YÜZÜKLÜ CONTA ÇIKIŞLI TE VANA** / Gasket Outlet Te Valve With Ring

Ürün Kodu Product Code	Bağlantı Çapı Diameter	Ambalaj Miktarı Packing Quantity		Koli Tipi Box Type	Koli Ağırlığı Box Weight	Fiyat Price
		poşet - bag	koli - box			
100-17-20-017	17 x 20 x 17	-	-	-	-	3,33
100-22-20-022	22 x 20 x 22	-	-	-	-	3,57
100-25-20-025	25 x 20 x 25	-	-	-	-	3,85



**YÜZÜKLÜ ERKEK DİŞLİ DİRSEK VANA** / Male Screwed Elbow Valve With Ring

Ürün Kodu Product Code	Bağlantı Çapı Diameter	Ambalaj Miktarı Packing Quantity		Koli Tipi Box Type	Koli Ağırlığı Box Weight	Fiyat Price
		poşet - bag	koli - box			
100-17-12-001	17 x ½	-	-	-	-	3,21
100-22-12-001	22 x ½	-	-	-	-	3,45
100-25-12-001	25 x ½	-	-	-	-	3,70



**YÜZÜKLÜ CONTA ÇIKIŞLI DİRSEK VANA** / Gasket Outlet Elbow Valve With Ring

Ürün Kodu Product Code	Bağlantı Çapı Diameter	Ambalaj Miktarı Packing Quantity		Koli Tipi Box Type	Koli Ağırlığı Box Weight	Fiyat Price
		poşet - bag	koli - box			
100-17-20-001	17 x 20	-	-	-	-	3,21
100-22-20-001	22 x 20	-	-	-	-	3,45
100-25-20-001	25 x 20	-	-	-	-	3,70



### KURT AĞIZLI LAY-FLAT ÇIKIŞLI MİNİ VANALAR / Dovetail Mini Valves With Lay-Flat Outlet

Ürün Kodu Product Code	Bağlantı Çapı Diameter	Ambalaj Miktarı Packing Quantity		Koli Tipi Box Type	Koli Ağırlığı Box Weight	Fiyat Price
		poşet - bag	koli - box			
100-16-22-001	1/2 x 16	80	400	B-1	12,050	1,60
100-20-22-002	1/2 x 20	80	320	-	-	2,00



### LAY-FLAT ÇIKIŞLI TAPE MİNİ VANALAR / Tape Mini Valves With Lay-Flat Outlet

Ürün Kodu Product Code	Bağlantı Çapı Diameter	Ambalaj Miktarı Packing Quantity		Koli Tipi Box Type	Koli Ağırlığı Box Weight	Fiyat Price
		poşet - bag	koli - box			
100-17-23-001	1/2 x 17	70	350	B-1	13,100	2,00
100-22-23-001	1/2 x 22	-	-	B-1	-	2,30



### LAY-FLAT ÇIKIŞLI YÜZÜKLÜ MİNİ VANALAR / Lay-Flat Outlet Mini Valves With Ring

Ürün Kodu Product Code	Bağlantı Çapı Diameter	Ambalaj Miktarı Packing Quantity		Koli Tipi Box Type	Koli Ağırlığı Box Weight	Fiyat Price
		poşet - bag	koli - box			
100-17-24-001	1/2 x 17	80	400	B-1	13,150	1,80
100-22-24-001	1/2 x 22	80	320	B-1	-	2,20
100-25-24-001	1/2 x 25	-	-	B-1	-	2,90
100-28-24-001	1/2 x 28	-	-	B-1	-	3,10



### LAY-FLAT ÇIKIŞLI ERKEK DİŞLİ MİNİ VANALAR / Male Screwed Mini Valves With Lay-Flat Outlet

Ürün Kodu Product Code	Bağlantı Çapı Diameter	Ambalaj Miktarı Packing Quantity		Koli Tipi Box Type	Koli Ağırlığı Box Weight	Fiyat Price
		poşet - bag	koli - box			
100-16-25-001	1/2 x 1/2	70	280	B-1	11,995	1,90



### DAMLA SULAMA EKLEME NİPELİ / Drip Irrigation Fitting Nipple

Ürün Kodu Product Code	Bağlantı Çapı Diameter	Ambalaj Miktarı Packing Quantity		Koli Tipi Box Type	Koli Ağırlığı Box Weight	Fiyat Price
		poşet - bag	koli - box			
150-16-01-001	16 x 16	550	2200	B-1	12,150	0,28
150-20-01-002	20 x 20	400	1600	B-1	10,150	0,30





**DAMLA SULAMA ÇIKIŞ NİPELİ** / Drip Irrigation Outlet Nipple

Ürün Kodu Product Code	Bağlantı Çapı Diameter	Ambalaj Miktarı Packing Quantity		Koli Tipi Box Type	Koli Ağırlığı Box Weight	Fiyat Price
		poşet - bag	koli - box			
200-16-01-001	16 x 16	550	2200	B-1	10,500	0,28
200-20-01-002	20 x 20	400	1600	B-1	8,850	0,30



**DAMLA SULAMA TE** / Drip Irrigation T

Ürün Kodu Product Code	Bağlantı Çapı Diameter	Ambalaj Miktarı Packing Quantity		Koli Tipi Box Type	Koli Ağırlığı Box Weight	Fiyat Price
		poşet - bag	koli - box			
250-16-03-001	16 x 16 x 16	350	1400	B-1	13,400	0,50
250-20-03-002	20 x 16 x 20	225	900	B-1	9,850	0,55
250-20-03-003	20 x 20 x 20	200	800	B-1	8,650	0,60



**DAMLA SULAMA DİRSEK** / Drip Irrigation Elbow

Ürün Kodu Product Code	Bağlantı Çapı Diameter	Ambalaj Miktarı Packing Quantity		Koli Tipi Box Type	Koli Ağırlığı Box Weight	Fiyat Price
		poşet - bag	koli - box			
300-16-04-001	16 x 16	550	2200	B-1	11,450	0,28
300-20-04-002	20 x 20	350	1400	B-1	9,250	0,30



**DAMLA SULAMA REDÜKSİYON** / Drip Irrigation Reduction

Ürün Kodu Product Code	Bağlantı Çapı Diameter	Ambalaj Miktarı Packing Quantity		Koli Tipi Box Type	Koli Ağırlığı Box Weight	Fiyat Price
		poşet - bag	koli - box			
500-20-08-001	20 x 16	500	2000	B-1	11,450	0,28



**DAMLA SULAMA KÖRTAPALARI** / Drip Irrigation Stoppers

Ürün Kodu Product Code	Bağlantı Çapı Diameter	Ambalaj Miktarı Packing Quantity		Koli Tipi Box Type	Koli Ağırlığı Box Weight	Fiyat Price
		poşet - bag	koli - box			
400-16-06-001	16 - Gözlük	750	3000	B-1	8,200	0,15
400-20-06-002	20 - Gözlük	400	1600	B-1	7,650	0,26
350-16-05-001	16 - Körtapa	800	3200	B-1	12,650	0,23
210-16-01-001	16 - Ana Boru Tapa	1100	4400	B-1	9,650	0,25



#### DAMLA SULAMA EKLEME NİPELİ TAPE / Drip Irrigation Fitting Nipple Tape

Ürün Kodu Product Code	Bağlantı Çapı Diameter	Ambalaj Miktarı Packing Quantity		Koli Tipi Box Type	Koli Ağırlığı Box Weight	Fiyat Price ₺
		poşet - bag	koli - box			
150-17-03-001	17 x 17	200	800	B-1	14,250	0,75



#### DAMLA SULAMA EKLEME NİPELİ KURTAĞIZLI TAPE / Drip Irrigation Fitting Nipple Dovetail Tape

Ürün Kodu Product Code	Bağlantı Çapı Diameter	Ambalaj Miktarı Packing Quantity		Koli Tipi Box Type	Koli Ağırlığı Box Weight	Fiyat Price ₺
		poşet - bag	koli - box			
200-17-01-001	16 x 17	300	1200	B-1	12,650	0,55



#### DAMLA SULAMA ÇIKIŞ NİPELİ TAPE / Drip Irrigation Outlet Nipple Tape

Ürün Kodu Product Code	Bağlantı Çapı Diameter	Ambalaj Miktarı Packing Quantity		Koli Tipi Box Type	Koli Ağırlığı Box Weight	Fiyat Price ₺
		poşet - bag	koli - box			
250-17-02-001	16 x 17	300	1200	B-1	14,450	0,55



#### DAMLA SULAMA ÇIKIŞ CONTASI / Drip Irrigation Outlet Gasket

Ürün Kodu Product Code	Bağlantı Çapı Diameter	Ambalaj Miktarı Packing Quantity		Koli Tipi Box Type	Koli Ağırlığı Box Weight	Fiyat Price ₺
		poşet - bag	koli - box			
450-16-20-001	16 Konik	1.100	4400	B-1	15,050	0,20
450-20-20-003	20 Konik	-	-	B-1	-	0,40
450-16-20-002	16 Kanallı	1.100	4400	B-1	13,450	0,20
450-20-20-004	20 Kanallı	1.000	4000	B-1	18,350	0,25
450-25-20-004	25 Kanallı	-	-	B-1	-	0,36
450-16-20-005	16 Tapa	1.000	4.000	B-1	-	0,23
450-20-20-005	20 Tapa	1.000	3.000	B-1	-	0,31

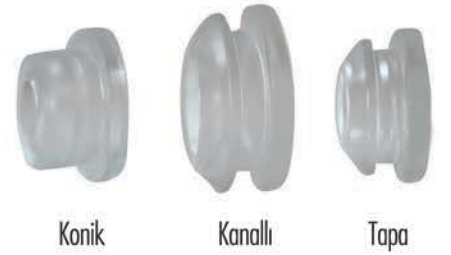

Konik

Kanallı

Tapa

#### DAMLATICI MEME / Dripper Nozzle

Ürün Kodu Product Code	Bağlantı Çapı Diameter	Ambalaj Miktarı Packing Quantity		Koli Tipi Box Type	Koli Ağırlığı Box Weight	Fiyat Price ₺
		poşet - bag	koli - box			
160-30-01-070	0-70	2.000	8000	B-1	15,350	0,16
160-30-01-140	0-140	1.000	4000	B-1	16,400	0,24



## ANA BORU DELME APARATI (MANUEL) / Main Pipe Perforation Tool (Manual)

Ürün Kodu Product Code	Bağlantı Çapı Diameter	Ambalaj Miktarı Packing Quantity	Koli Tipi Box Type	Koli Ağırlığı Box Weight	Fiyat ₺ Price	
	mm	poşet - bag	koli - box	kg		
950-14-01-001	14	50	300	B-1	25,000	10,50
950-16-01-001	16	50	300	B-1	25,550	10,50
950-20-01-001	20	50	300	B-1	26,750	10,50
950-25-01-001	25	50	300	B-1	-	17,00



## ANA BORU DELME APARATI (MATKAP İÇİN) / Main Pipe Perforation Tool (For Drill)

Ürün Kodu Product Code	Bağlantı Çapı Diameter	Ambalaj Miktarı Packing Quantity	Koli Tipi Box Type	Koli Ağırlığı Box Weight	Fiyat ₺ Price	
	mm	poşet - bag	koli - box	kg		
950-14-01-002	14	100	-	-	3,100	10,00
950-16-01-002	16	100	-	-	3,500	10,00
950-20-01-002	20	100	-	-	4,100	10,00
950-25-01-002	25	100	-	-	-	16,00



## DRİP DELME APARATI / Perforation Tool For Dripper

Ürün Kodu Product Code	Bağlantı Çapı Diameter	Ambalaj Miktarı Packing Quantity	Koli Tipi Box Type	Koli Ağırlığı Box Weight	Fiyat ₺ Price	
	mm	poşet - bag	koli - box	kg		
900-30-01-002	3,0	50	500	B-1	21,150	10,00



## YÜZÜKLÜ CONTA ÇIKIŞLI TE / Gasket Outlet Te With Ring

Ürün Kodu Product Code	Bağlantı Çapı Diameter	Ambalaj Miktarı Packing Quantity	Koli Tipi Box Type	Koli Ağırlığı Box Weight	Fiyat ₺ Price
	mm	poşet - bag	koli - box	kg	
17-17-16-017	17 x 16 x 17	-	-	-	1,70
17-17-20-017	17 x 20 x 17	-	-	-	1,80
17-22-20-022	22 x 20 x 22	-	-	-	1,90
17-25-20-025	25 x 20 x 25	-	-	-	2,40



## YÜZÜKLÜ ERKEK DİŞLİ TE / Male Screwed Te With Ring

Ürün Kodu Product Code	Bağlantı Çapı Diameter	Ambalaj Miktarı Packing Quantity	Koli Tipi Box Type	Koli Ağırlığı Box Weight	Fiyat ₺ Price
	mm	poşet - bag	koli - box	kg	
18-17-12-017	17 x 1/2 x 17	-	-	-	1,80
18-22-12-022	22 x 1/2 x 22	-	-	-	1,90
18-25-12-025	25 x 1/2 x 25	-	-	-	2,40



### EKLEME NİPELİ YÜZÜKLÜ / Nipple With Ring

Ürün Kodu Product Code	Bağlantı Çapı Diameter	Ambalaj Miktarı Packing Quantity		Koli Tipi Box Type	Koli Ağırlığı Box Weight	Fiyat Price ₺
		poşet - bag	koli - box			
150-017-17-001	17 x 17	400	1600	B-1	12,050	0,38
150-022-22-001	22 x 22	200	800	B-1	10,100	0,66
150-025-25-001	25 x 25	-	-	B-1	-	0,81
150-028-28-001	28 x 28	-	-	B-1	-	0,96



### KÖRTAPA YÜZÜKLÜ / Stopper With Ring

Ürün Kodu Product Code	Bağlantı Çapı Diameter	Ambalaj Miktarı Packing Quantity		Koli Tipi Box Type	Koli Ağırlığı Box Weight	Fiyat Price ₺
		poşet - bag	koli - box			
350-17-05-001	17	500	2000	B-1	10,850	0,25
350-22-05-001	22	250	1000	B-1	9,150	0,38



### KURT AĞIZLI YÜZÜKLÜ NİPEL / Dovetail Nipple With Ring

Ürün Kodu Product Code	Bağlantı Çapı Diameter	Ambalaj Miktarı Packing Quantity		Koli Tipi Box Type	Koli Ağırlığı Box Weight	Fiyat Price ₺
		poşet - bag	koli - box			
250-17-16-001	17 x 16	500	2000	B-1	10,950	0,25
250-22-20-001	22 x 20	200	800	B-1	7,600	0,45



### CONTA ÇIKIŞLI YÜZÜKLÜ NİPEL / Nipple With Gasket Outlet And Ring

Ürün Kodu Product Code	Bağlantı Çapı Diameter	Ambalaj Miktarı Packing Quantity		Koli Tipi Box Type	Koli Ağırlığı Box Weight	Fiyat Price ₺
		poşet - bag	koli - box			
200-17-16-001	17 x 16	500	2000	B-1	11,200	0,25
200-22-20-001	22 x 20	200	800	B-1	8,000	0,45
200-25-20-001	25 x 20	-	-	B-1	-	0,53
200-25-25-001	25 x 25	-	-	B-1	-	0,59
200-28-25-001	28 x 25	-	-	B-1	-	0,68



# AYAS

tarımsal sulama ekipmanları

## Filtre Sistemleri

### Filter Systems



### İKİZ PLASTİK DİSK FİLTRELER / Double Plastic Disc Filters



Bağlantı Tipi - Connection Type

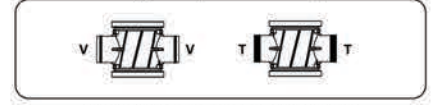

V : Viktolik-Victualic T : Dişli-Threaded

■ 130 micron / 120 mesh

Ürün Kodu Product Code	Bağlantı Çapı Connection Diameter	Bağlantı Tipi Connection Type	Cinsi Type	Filtrasyon Yüzeyi Filtration Surface	Koli Tipi Box Type	Fiyat Price
	inch			m <sup>2</sup> /h		₺
960-030-01-01 960-030-01-02	3"	BSPT x BSPT V x V	Kısa	50	B-4	870,00
960-030-02-01 960-030-02-02		BSPT x BSPT V x V	Uzun	60	B-5	1.000,00
960-040-01-01 960-040-01-02	4"	BSPT x BSPT V x V	Kısa	70	B-4	870,00
960-040-02-01 960-040-02-02		BSPT x BSPT V x V	Uzun	90	B-5	1.000,00

### TEKLİ PLASTİK DİSK FİLTRELER / Single Plastic Disc Filters



Bağlantı Tipi - Connection Type



V : Viktolik-Victualic T : Dişli-Threaded

■ 130 micron / 120 mesh

Ürün Kodu Product Code	Bağlantı Çapı Connection Diameter	Bağlantı Tipi Connection Type	Cinsi Type	Filtrasyon Yüzeyi Filtration Surface	Koli Tipi Box Type	Fiyat Price			
	inch			m <sup>2</sup> /h		₺			
910-020-01-01 910-020-01-02 910-020-01-03	2"	BSPT x BSPT x BSPT V x V x BSPT V x BSPT x V	Kısa	25	B-3	510,00			
910-020-02-01 910-020-02-02 910-020-02-03		BSPT x BSPT x BSPT V x V x BSPT V x BSPT x V					Uzun	30	575,00
910-025-01-01 910-025-01-02 910-025-01-03		BSPT x BSPT x BSPT V x V x BSPT V x BSPT x V					Kısa	35	B-3
910-025-02-01 910-025-02-02 910-025-02-03	BSPT x BSPT x BSPT V x V x BSPT V x BSPT x V	Uzun	40	575,00					
910-030-01-01 910-030-01-02 910-030-01-03	3"	BSPT x BSPT x BSPT V x V x BSPT V x BSPT x V	Kısa	40	B-3	510,00			
910-030-02-01 910-030-02-02 910-030-02-03		BSPT x BSPT x BSPT V x V x BSPT V x BSPT x V					Uzun	45	575,00

**İKİZ PLASTİK ELEK FİLTRELER / Double Plastic Screen Filters**



Bağlantı Tipi - Connection Type

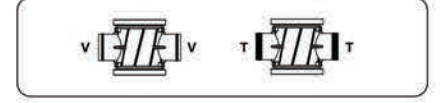

V : Viktolik-Victualic T : Dişli-Threaded

- 530 micron / 35 mesh
- 130 micron / 120 mesh
- 200 micron / 75 mesh
- 100 micron / 150 mesh

Ürün Kodu Product Code	Bağlantı Çapı Connection Diameter	Bağlantı Tipi Connection Type	Cinsi Type	Filtrasyon Yüzeyi Filtration Surface	Koli Tipi Box Type	Fiyat Price
	inch			m <sup>3</sup> /h		
960-030-01-03 960-030-01-04	3"	BSPT x BSPT V x V	Kısa	50	B-4	920,00
960-030-02-03 960-030-02-04		BSPT x BSPT V x V	Uzun	60	B-5	1.080,00
960-040-01-03 960-040-01-04	4"	BSPT x BSPT V x V	Kısa	70	B-4	920,00
960-040-02-03 960-040-02-04		BSPT x BSPT V x V	Uzun	90	B-5	1.080,00

**TEKLİ PLASTİK ELEK FİLTRELER / Single Plastic Screen Filters**



Bağlantı Tipi - Connection Type



V : Viktolik-Victualic T : Dişli-Threaded

- 530 micron / 35 mesh
- 130 micron / 120 mesh
- 200 micron / 75 mesh
- 100 micron / 150 mesh

Ürün Kodu Product Code	Bağlantı Çapı Connection Diameter	Bağlantı Tipi Connection Type	Cinsi Type	Filtrasyon Yüzeyi Filtration Surface	Koli Tipi Box Type	Fiyat Price	
	inch			m <sup>3</sup> /h			
910-020-01-04 910-020-01-05 910-020-01-06	2"	BSPT x BSPT x BSPT V x V x BSPT V x BSPT x V	Kısa	25	B-3	535,00	
910-020-02-04 910-020-02-05 910-020-02-06		BSPT x BSPT x BSPT V x V x BSPT V x BSPT x V	Uzun	30			615,00
910-025-01-04 910-025-01-05 910-025-01-06		2½"	BSPT x BSPT x BSPT V x V x BSPT V x BSPT x V	Kısa			35
910-025-02-04 910-025-02-05 910-025-02-06	BSPT x BSPT x BSPT V x V x BSPT V x BSPT x V		Uzun	40	615,00		
910-030-01-04 910-030-01-05 910-030-01-06	3"		BSPT x BSPT x BSPT V x V x BSPT V x BSPT x V	Kısa	40	B-3	535,00
910-030-02-04 910-030-02-05 910-030-02-06		BSPT x BSPT x BSPT V x V x BSPT V x BSPT x V	Uzun	45	615,00		

Filtre kelepçeleri mühendislik plastiğinden üretilmiştir.  
Filter clamps are produced of engineering plastic.

### İKİZ PLASTİK DİSK FİLTRELER / Double Plastic Disc Filters



Bağlantı Tipi - Connection Type

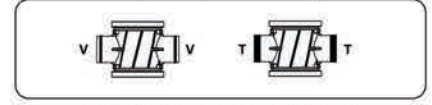

V : Viktolik-Victualic T : Dişli-Threaded

■ 130 micron / 120 mesh

Ürün Kodu Product Code	Bağlantı Çapı Connection Diameter	Bağlantı Tipi Connection Type	Cinsi Type	Filtrasyon Yüzeyi Filtration Surface	Koli Tipi Box Type	Fiyat Price
	inch			m <sup>2</sup> /h		₺
950-030-01-01	3"	BSPT x BSPT	Kısa	50	B-4	1.025,00
950-030-01-02		V x V				
950-030-02-01		BSPT x BSPT	Uzun			
950-030-02-02		V x V				
950-040-01-01	4"	BSPT x BSPT	Kısa	70	B-4	1.025,00
950-040-01-02		V x V				
950-040-02-01		BSPT x BSPT	Uzun			
950-040-02-02		V x V				

### TEKLİ PLASTİK DİSK FİLTRELER / Single Plastic Disc Filters



Bağlantı Tipi - Connection Type



V : Viktolik-Victualic T : Dişli-Threaded

■ 130 micron / 120 mesh

Ürün Kodu Product Code	Bağlantı Çapı Connection Diameter	Bağlantı Tipi Connection Type	Cinsi Type	Filtrasyon Yüzeyi Filtration Surface	Koli Tipi Box Type	Fiyat Price
	inch			m <sup>2</sup> /h		₺
900-020-01-01	2"	BSPT x BSPT x BSPT	Kısa	25	B-3	590,00
900-020-01-02		V x V x BSPT				
900-020-01-03		V x BSPT x V				
900-020-02-01		BSPT x BSPT x BSPT	Uzun			
900-020-02-02		V x V x BSPT				
900-020-02-03		V x BSPT x V				
900-025-01-01	2½"	BSPT x BSPT x BSPT	Kısa	35	B-3	590,00
900-025-01-02		V x V x BSPT				
900-025-01-03		V x BSPT x V				
900-025-02-01		BSPT x BSPT x BSPT	Uzun			
900-025-02-02		V x V x BSPT				
900-025-02-03		V x BSPT x V				
900-030-01-01	3"	BSPT x BSPT x BSPT	Kısa	40	B-3	590,00
900-030-01-02		V x V x BSPT				
900-030-01-03		V x BSPT x V				
900-030-02-01		BSPT x BSPT x BSPT	Uzun			
900-030-02-02		V x V x BSPT				
900-030-02-03		V x BSPT x V				



İKİZ PLASTİK ELEK FİLTRELER / Double Plastic Screen Filters



Bağlantı Tipi - Connection Type

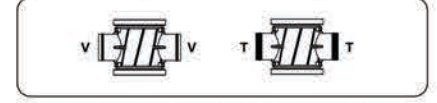

V : Viktolik-Victualic T : Dişli-Threaded

- 530 micron / 35 mesh 130 micron / 120 mesh  
200 micron / 75 mesh 100 micron / 150 mesh

Ürün Kodu Product Code	Bağlantı Çapı Connection Diameter	Bağlantı Tipi Connection Type	Cinsi Type	Filtrasyon Yüzeyi Filtration Surface	Koli Tipi Box Type	Fiyat Price
	inch			m <sup>3</sup> /h		₺
950-030-01-03 950-030-01-04	3"	BSPT x BSPT V x V	Kısa	50	B-4	1.075,00
950-030-02-03 950-030-02-04		BSPT x BSPT V x V	Uzun	60	B-5	1.235,00
950-040-01-03 950-040-01-04	4"	BSPT x BSPT V x V	Kısa	70	B-4	1.075,00
950-040-02-03 950-040-02-04		BSPT x BSPT V x V	Uzun	90	B-5	1.235,00

TEKLİ PLASTİK ELEK FİLTRELER / Single Plastic Screen Filters



Bağlantı Tipi - Connection Type



V : Viktolik-Victualic T : Dişli-Threaded

- 530 micron / 35 mesh 130 micron / 120 mesh  
200 micron / 75 mesh 100 micron / 150 mesh

Ürün Kodu Product Code	Bağlantı Çapı Connection Diameter	Bağlantı Tipi Connection Type	Cinsi Type	Filtrasyon Yüzeyi Filtration Surface	Koli Tipi Box Type	Fiyat Price	
	inch			m <sup>3</sup> /h		₺	
900-020-01-04 900-020-01-05 900-020-01-06	2"	BSPT x BSPT x BSPT V x V x BSPT V x BSPT x V	Kısa	25	B-3	615,00	
900-020-02-04 900-020-02-05 900-020-02-06		BSPT x BSPT x BSPT V x V x BSPT V x BSPT x V	Uzun	30			695,00
900-025-01-04 900-025-01-05 900-025-01-06		2½"	BSPT x BSPT x BSPT V x V x BSPT V x BSPT x V	Kısa			35
900-025-02-04 900-025-02-05 900-025-02-06	BSPT x BSPT x BSPT V x V x BSPT V x BSPT x V		Uzun	40	695,00		
900-030-01-04 900-030-01-05 900-030-01-06	3"		BSPT x BSPT x BSPT V x V x BSPT V x BSPT x V	Kısa	40	B-3	615,00
900-030-02-04 900-030-02-05 900-030-02-06		BSPT x BSPT x BSPT V x V x BSPT V x BSPT x V	Uzun	45	695,00		

Filtre kelepçeleri paslanmaz çelikten üretilmiştir.  
Filter clamps are produced of stainless steel.

### Y TİP DİSK FİLTRELER / Y Type Disc Filters



■ 130 micron / 120 mesh

Ürün Kodu Product Code	Bağlantı Çapı Connection Diameter	Bağlantı Tipi Connection Type	Kapasite Capacity	Filtrasyon Yüzeyi Filtration Surface	Ambalaj Miktarı Packing Quantity		Koli Tipi Box Type	Fiyat ₺ Price
	inch		m <sup>3</sup> /h		poşet / bag	koli / box		
800-112-01-01	1 ½"	BSPT x BSPT	20	559,20	1	15	B-2	74,00
800-200-01-01	2"	BSPT x BSPT	25					74,00

### Y TİP DİSK FİLTRELER / Y Type Disc Filters



■ 130 micron / 120 mesh

Ürün Kodu Product Code	Bağlantı Çapı Connection Diameter	Bağlantı Tipi Connection Type	Kapasite Capacity	Filtrasyon Yüzeyi Filtration Surface	Ambalaj Miktarı Packing Quantity		Koli Tipi Box Type	Fiyat ₺ Price
	inch		m <sup>3</sup> /h		poşet / bag	koli / box		
800-114-02-01	1 ¼"	BSPT x BSPT	10	311,96	1	32	B-2	41,00
800-112-02-01	1 ½"	BSPT x BSPT	15					41,00

### Y TİP DİSK FİLTRELER / Y Type Disc Filters



■ 130 micron / 120 mesh

Ürün Kodu Product Code	Bağlantı Çapı Connection Diameter	Bağlantı Tipi Connection Type	Kapasite Capacity	Filtrasyon Yüzeyi Filtration Surface	Ambalaj Miktarı Packing Quantity		Koli Tipi Box Type	Fiyat ₺ Price
	inch		m <sup>3</sup> /h		poşet / bag	koli / box		
800-034-03-01	¾"	BSPT x BSPT	-	172,25	1	60	B-2	26,00
800-100-03-01	1"	BSPT x BSPT	-					26,00

Y TİP ELEK FİLTRELER / Y Type Screen Filters



- 530 micron / 35 mesh
- 200 micron / 75 mesh
- 130 micron / 120 mesh
- 100 micron / 150 mesh

Ürün Kodu Product Code	Bağlantı Çapı Connection Diameter	Bağlantı Tipi Connection Type	Kapasite Capacity	Filtrasyon Yüzeği Filtration Surface	Ambalaj Miktarı Packing Quantity		Koli Tipi Box Type	Fiyat ₺ Price
					poşet / bag	koli / box		
800-112-01-02	1 1/2"	BSPT x BSPT	20	525,43	1	15	B-2	77,00
800-200-01-02	2"	BSPT x BSPT	25					77,00

Y TİP ELEK FİLTRELER / Y Type Screen Filters



- 530 micron / 35 mesh
- 200 micron / 75 mesh
- 130 micron / 120 mesh
- 100 micron / 150 mesh

Ürün Kodu Product Code	Bağlantı Çapı Connection Diameter	Bağlantı Tipi Connection Type	Kapasite Capacity	Filtrasyon Yüzeği Filtration Surface	Ambalaj Miktarı Packing Quantity		Koli Tipi Box Type	Fiyat ₺ Price
					poşet / bag	koli / box		
800-114-02-02	1 1/4"	BSPT x BSPT	10	322,54	1	32	B-2	47,00
800-112-02-02	1 1/2"	BSPT x BSPT	15					47,00

Y TİP ELEK FİLTRELER / Y Type Screen Filters



- 530 micron / 35 mesh
- 200 micron / 75 mesh
- 130 micron / 120 mesh
- 100 micron / 150 mesh

Ürün Kodu Product Code	Bağlantı Çapı Connection Diameter	Bağlantı Tipi Connection Type	Kapasite Capacity	Filtrasyon Yüzeği Filtration Surface	Ambalaj Miktarı Packing Quantity		Koli Tipi Box Type	Fiyat ₺ Price
					poşet / bag	koli / box		
800-034-03-02	3/4"	BSPT x BSPT	-	178,47	1	60	B-2	34,00
800-100-03-02	1"	BSPT x BSPT	-					34,00

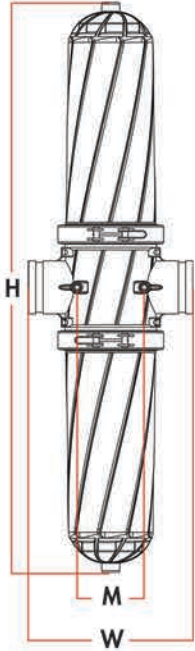

Bağlantı Çapı Connection Diameter	Cinsi Type	W	H	M
inch		mm	mm	mm
3"	Kısa - Short	340	960	140
	Uzun - Long		1200	
4"	Kısa - Short	340	960	140
	Uzun - Long		1200	

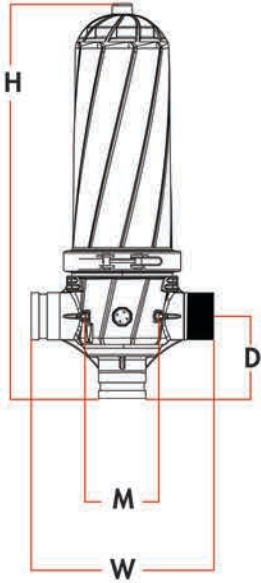

Bağlantı Çapı Connection Diameter	Cinsi Type	W	H	M	D
inch		mm	mm	mm	mm
2"	Kısa - Short	340	630	140	160
	Uzun - Long		740		
2 1/2"	Kısa - Short	340	630	140	160
	Uzun - Long		740		
3"	Kısa - Short	340	630	140	160
	Uzun - Long		740		

### Ölçüler / Dimensions

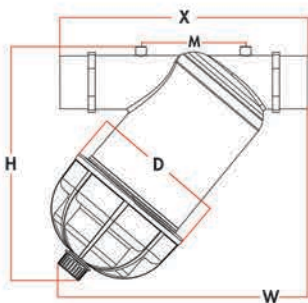

Cinsi Type	Bağlantı Çapı Connection Diameter	X	W	M	H	D
	inch	mm	mm	mm	mm	mm
+ Plus	1 1/2" x 1 1/2"	263	275	110	250	143
	2" x 2"					
midi	1 1/4" x 1 1/4"	230	225	95	205	115
	1 1/2" x 1 1/2"					
mini	3/4" x 3/4"	170	182	70	170	93,5
	1" x 1"					

**PLASTİK FİLTRELİ HİDROSİKLOKON**

/ Plastic Filter Hydrocyclone



**HİDROSİKLOKON / Hydrocyclone**



**BYPAS'LI GRAVEL TANK**

/ Gravel Tank With ByPass



Ürün Kodu Product Code	Bağlantı Çapı Connection Diameter	Fiyat ₺ Price
	inch	
970-006-020	2"	3.750,00
970-006-025	2½"	3.940,00
970-006-030	3"	5.200,00
970-006-040	4"	6.550,00

Ürün Kodu Product Code	Bağlantı Çapı Connection Diameter	Fiyat ₺ Price
	inch	
970-005-025	2½"	2.060,00
970-005-030	3"	3.050,00
970-005-040	4"	3.370,00
970-005-050	5"	5.150,00
970-005-060	6"	5.400,00

Ürün Kodu Product Code	Bağlantı Çapı Connection Diameter	Fiyat ₺ Price
	inch	
970-003-020	2"	4.450,00
970-003-025	2½"	5.620,00
970-003-030	3"	6.790,00
970-003-040	4"	7.260,00

**GÜBRE TANKI / Fertilizer Tank**



**ALTAN ÇIKIŞLI GÜBRE TANKI**

/ Fertilizer Tank With Bottom Outlet



**PLS. FİLTRELİ BYPAS'LI GRAVEL TANK**

/ Bypassed Gravel Tank With Plastic Filter



Ürün Kodu Product Code	Kapasite Capacity	Fiyat ₺ Price
	lt	
970-001-100	100	1.250,00
970-001-200	200	1.550,00
970-001-300	300	1.800,00
970-001-400	400	2.200,00
970-001-500	500	2.950,00

Ürün Kodu Product Code	Kapasite Capacity	Fiyat ₺ Price
	lt	
970-002-200	200	2.950,00
970-002-300	300	3.150,00
970-002-400	400	3.400,00
970-002-500	500	3.700,00

Ürün Kodu Product Code	Bağlantı Çapı Connection Diameter	Fiyat ₺ Price
	inch	
970-004-020	2"	5.620,00
970-004-025	2½"	6.790,00
970-004-030	3"	7.960,00
970-004-040	4"	8.430,00

### PLASTİK FİLTRELİ ŞASELİ SİSTEM / Portable Systems With Plastic Filter

Ürün Kodu Product Code	Bağlantı Çapı Connection Diameter	Fiyat Price
	inch	₺
970-007-432	4" 3x2	13.400,00
970-007-552	5" 4x2	15.000,00
970-007-543	5" 4x3	17.100,00
970-007-643	6" 4x3	19.700,00
970-007-644	6" 4x4	22.500,00
970-007-645	6" 4x5	24.600,00



### PLASTİK FİLTRELİ MOBİL SİSTEM / Mobil Systems With Plastic Filter

Ürün Kodu Product Code	Bağlantı Çapı Connection Diameter	Fiyat Price
	inch	₺
970-008-542	5" 4x2	16.400,00
970-008-543	5" 4x3	19.200,00
970-008-643	6" 4x3	21.550,00
970-008-644	6" 4x4	24.600,00
970-008-645	6" 4x5	27.000,00



### PLASTİK FİLTRELİ ŞASELİ KOLLEKTÖR SİSTEM / Portable Collector Systems With Plastic Filters

Ürün Kodu Product Code	Açıklama Explanation	Bağ. Çapı Diameter	Kapasite Capacity	Filtre Adedi Filter Piece	Fiyat Price
		inch	m <sup>3</sup> /h		₺
985-200-0510	Tekli Plastik Filtreli Single Plastic Filter	2"	5 - 10	2 x 2"	12.670,00
985-200-1015		2"	10 - 15		
985-200-1520		2"	15 - 20		
985-250-2025		2½"	20 - 25		
985-250-2530		2½"	25 - 30		
985-250-3035	2½"	30 - 35	2 x 2½"	12.880,00	
985-300-3545	3"	35 - 45			
985-300-4555	3"	45 - 55			
985-400-5570	4"	55 - 70			
985-400-7090	4"	70 - 90			
985-500-9011	İkiz Plastik Filtreli Double Plastic Filter	5"	90 - 110	2 x 4"	28.930,00
985-500-1113		5"	110 - 130		
985-600-1318		6"	130 - 180		
985-800-1825		8"	180 - 250		
		6"	180 - 250		
				6 x 4"	55.000,00

İÇ ANADOLU BÖLGE BAYI

**CESURSAN**  
FİLTRE  
CESURSAN TARIMSAL SULAMA SİSTEMLERİ



## KELEBEK VANA / Butterfly Valve

Ürün Kodu Product Code	Bağlantı Çapı Connection Diameter	Fiyat Price
	inch	
063-000-711	2"	95,00
075-000-711	2½"	100,00
090-000-711	3"	115,00
110-000-711	4"	142,50
125-000-711	5"	190,00
160-000-711	6"	240,00



Toprakaltı için  
fiyat farkı sorunuz  
Please Ask the Price for  
Butterfly Valve With Undersoil

## İÇTEN DİŞLİ KELEBEK VANA / Female Threaded Butterfly Valve

Ürün Kodu Product Code	Bağlantı Çapı Connection Diameter	Fiyat Price
	inch	
063-000-713	2"	93,50
075-000-713	2½"	104,00
090-000-713	3"	126,00
110-000-713	4"	170,00
125-000-713	5"	190,00



Toprakaltı için  
fiyat farkı sorunuz  
Please Ask the Price for  
Butterfly Valve With Undersoil

## ARA GÜBRELEME VANASI / Fertilizing Valve

Ürün Kodu Product Code	Bağlantı Çapı Connection Diameter	Fiyat Price
	inch	
063-000-715	2"	120,00
075-000-715	2½"	140,00
090-000-715	3"	173,00
110-000-715	4"	238,00
125-000-715	5"	310,00



## ÜÇ YOLLU KELEBEK VANA / Three-way Outlet Butterfly Valve

Ürün Kodu Product Code	Bağlantı Çapı Connection Diameter	Fiyat Price
	inch	
090-000-716	3"	123,00
110-000-716	4"	164,00



## VİKTOLİK KELEPÇE(ALÜMİNYUM) / Victualic Clamp (Aluminium)

Ürün Kodu Product Code	Bağlantı Çapı Connection Diameter	Fiyat Price
	inch	
063-000-718	2"	37,00
075-000-718	2½"	38,00
090-000-718	3"	48,00
110-000-718	4"	66,00
125-000-718	5"	85,00
160-000-718	6"	100,00



### PLASTİK FİLTRE İÇ TAKIM DİSK / Disc Cartridge for Plastic Filter

Ürün Kodu Product Code	Ürün Ölçüleri Product Dimensions	Ambalaj Miktarı Packing Quantity	Koli Tipi Box Type	Fiyat Price
	tip / type	koli / box		₺
999-234-00-01	2"-2½"-3"-4" Kısa	12	B-2	106,00
999-234-00-02	2"-2½"-3"-4" Uzun	8	B-2	133,00



■ 130 micron / 120 mesh

### FİLTRE İÇ TAKIM ELEK / Screen Cartridge

Ürün Kodu Product Code	Ürün Ölçüleri Product Dimensions	Ambalaj Miktarı Packing Quantity	Koli Tipi Box Type	Fiyat Price
	cm	koli / box		₺
997-020-00-01	12,5	60	B-2	42,00
997-025-00-01	25	28	B-2	84,00
997-030-00-01	37,5	16	B-2	126,00
997-040-00-01	50	12	B-2	168,00



■ 530 micron / 35 mesh  
■ 200 micron / 75 mesh  
■ 130 micron / 120 mesh  
■ 100 micron / 150 mesh

### METAL FİLTRE İÇ TAKIM DİSK / Disc Cartridge For Metal Filter

Ürün Kodu Product Code	Ürün Ölçüleri Product Dimensions	Ambalaj Miktarı Packing Quantity	Koli Tipi Box Type	Fiyat Price	
	inch	cm	koli / box	₺	
998-020-25-01	2"	25	18	B-2	70,00
998-025-35-01	2½"	35	12	B-2	97,00
998-030-40-01	3"	40	12	B-2	108,00
998-040-50-01	4"	50	8	B-2	135,00
998-050-60-01	5"	60	8	B-2	158,00



■ 130 micron / 120 mesh

### Y TİP FİLTRE İÇ TAKIM DİSK / Disc Cartridge For Y Type Filter

Ürün Kodu Product Code	Açıklama Explanation	Ambalaj Miktarı Packing Quantity	Koli Tipi Box Type	Fiyat Price
		koli / box		₺
899-100-01-01	+plus	28	B-1	30,00
899-200-02-01	midi	54	B-1	16,00
899-300-03-01	mini	112	B-1	8,00



■ 130 micron / 120 mesh

### Y TİP FİLTRE İÇ TAKIM ELEK / Screen Cartridge For Y Type Filter

Ürün Kodu Product Code	Açıklama Explanation	Ambalaj Miktarı Packing Quantity	Koli Tipi Box Type	Fiyat Price
		koli / box		₺
897-100-01-02	+plus	28	B-1	32,00
897-200-02-02	midi	54	B-1	22,00
897-300-03-02	mini	112	B-1	16,00



■ 530 micron / 35 mesh  
■ 200 micron / 75 mesh  
■ 130 micron / 120 mesh  
■ 100 micron / 150 mesh



# AYAS

tarımsal sulama ekipmanları

## Yeni Nesil Kaplinler

New Generation Compression Fittings



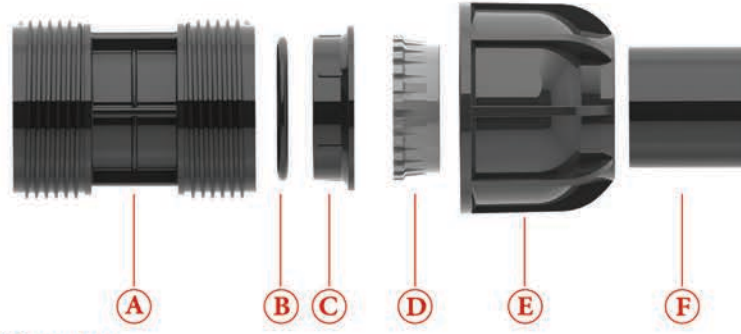

### TEKNİK BİLGİLER / Technical information

Ürünlerimiz ISO 3858 - ISO 1167/1 - ISO 1167/4 - ISO 3501- ISO 3503 - ISO 3459

ISO 13844 - ISO 13845 - ISO 1133/1 standartlarına sahiptir.

Our products have ISO 3858 - ISO 1167/1 - ISO 1167/4 - ISO 3501- ISO 3503 - ISO 3459 ISO 13844 - ISO 13845 - ISO 1133/1 standards.

**ÇALIŞMA BASINCI / Working Pressure :** PN 10

**ÇAP ARALIĞI / Diameter Range :** Ø20 - Ø110 mm

A GÖVDE / Body   
 B O-RING / O-Ring   
 C ENGELLEYİCİ / Blocker   
 D SIKMA PARÇASI / Clamping Part   
 E SOMUN / Nut   
 F BORU / Pipe

## KAPLINLERİN MONTAJ YÖNTEMİ / Assembly Method of Compression Fittings

- ①  Boruyu, boru eksenine dik olarak bir kesici aparat ile kesiniz. Boru ucunda çapak kalmamasına dikkat ediniz.  
Cut the pipe using a cutting tool in vertical position to the pipe axis. Make sure that no burr remains at the end of the pipe.



Adaptörünüzün somununu yaklaşık 4 tam tur döndürüp gevşetiniz. Boruyu, adaptörünüzün iç kısmındaki \*boru dayanma noktasına kadar iyice itiniz.  
Loosen the nut of your compression fitting rotating approximately 4 full circles. Push the pipe properly until the \*pipe retaining point inside the pipe.

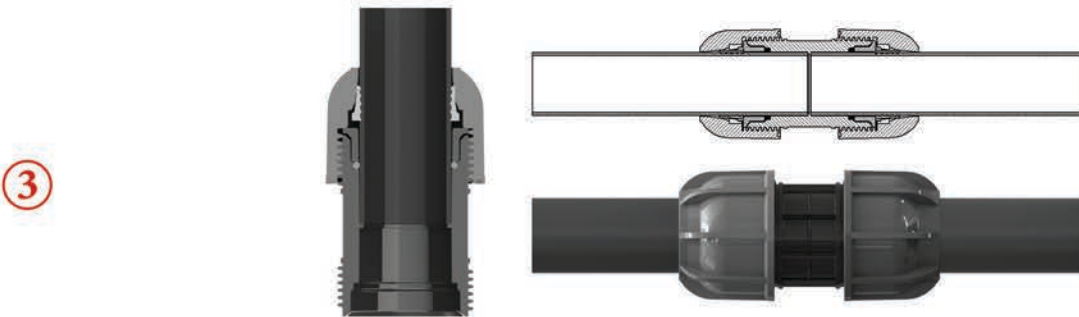

Somunu el ile sıkınız. (32 mm ve 32 mm'den büyük borularda ERHAS Kaplin Anahtarı ile sıkınız.)

Tighten nut by hand (Tighten 32 mm and pipes bigger than 32 mm using ERHAS Coupling wrench)

**ERHAS YENİ NESİL KAPLİNLER****ÖZELLİKLERİ :**

- Hammaddesi polipropilen olup, kimyasal direnci yüksek polimerlerden oluşmuş ve darbe direnci iyileştirilmiştir.
- Borulardaki  $\pm 0,5$  mm'ye kadar ölçü farklılıklarından veya ovalikten oluşabilecek sorunları PCT Patent belgeli konik sıkma, kolay montaj ve sızdırmazlık özelliği ile önler.
- Avrupa tasarım tescil belgeli estetik tasarım ve görseelliğe sahiptir.
- Kolayca sökülüp takılabildiğinden işçilik ve malzeme maliyetini azaltır.
- Hafif olduğundan montajı ve nakliyesi kolaydır.
- Korozyona dayanıklı olup kireçlenme ve paslanma yapmaz.
- UV (ultraviyole) ışınları geçirmediği için yosunlanmaya ve bakteri üremesine izin vermez.
- İç yüzeyleri homojen ve gözeneksiz olup hiçbir yabancı madde içermediğinden zararsızdır. Suyun kokusunu ve tadını değiştirmez.
- Yüksek darbe dayanımı vardır. Darbeli basınçlara dayanıklıdır.
- O-Ring'i tabii kauçuktan imal edilmekte olup yüksek sızdırmazlık sağlar.
- Boru tutucu poliasetalden üretilmektedir.

**KULLANIM ALANLARI :**

- Şehir şebekesi , içme suyu
- Tarımsal sulama
- Seralar
- Peyzaj sektörü

*Garanti verilen basınç değerleri : Ø20 mm-Ø110 mm PN 10*

**ERHAS NEW GENERATION COMPRESSION FITTINGS****SPECIFICATIONS:**

- Its raw material is polypropylene, its chemical resistance is formed of high polymers and its impact resistance is improved.
- It prevents the problems which may arise due to size differences up to  $\pm 0,5$  mm in the pipes or ovality with its PCT Patent Certificate conical tightening, easy-to-assemble and sealing features.
- Aesthetics design and visaulity with European registration certificate.
- It decreases the labor and material cost as it is easily fixed and unfixed.
- As it is light, its installation and transportation is easy.
- It is resistant to corrosion and does not cause any calcification and rusting.
- As it does not conduct UV (ultraviolet) rays, it does not allow mossing and bacterial growth.
- The interior surfaces are of homogenous and non-porous and is harmless as it contains no foreign matters. It does not change the odor and flavor of water.
- It is high impact resistance. It is resistant to pulsed pressures.
- Its o-ring is made of natural rubber and provides high sealing.
- Clamping Part is made of polyacetal.

**AREAS OF USAGE :**

- City and drinking water
- Agricultural irrigation
- Greenhouses
- Landscape sector

*Guaranteed pressure values : Ø20 mm-Ø110 mm PN 10*

### ERKEK KAPLİN Pn=10 / Male Coupling Pn=10

Koli Tipi **B-2**  
Çuval Tipi **S-1**

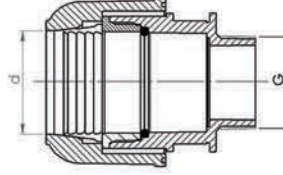

Ürün Kodu Product Code	Ürün Çapı Diameter	Ambalaj Miktarı Packing Quantity			Fiyat Price ₺	Ürün Kodu Product Code	Ürün Çapı Diameter	Ambalaj Miktarı Packing Quantity			Fiyat Price ₺
		d x G	poşet - bag	koli - box				çuval - sack	d x G	poşet - bag	
110-020-10001	20 x 1/2"	100	800	1000	1,20	110-063-10044	63 x 1 1/4"	12	72	96	12,80
110-020-10002	20 x 3/4"	100	800	1000	1,20	110-063-10045	63 x 1 1/2"	12	72	96	12,80
110-025-10005	25 x 1/2"	50	400	500	2,40	110-063-10047	63 x 2"	12	72	96	12,80
110-025-10006	25 x 3/4"	50	400	500	2,40	110-063-10049	63 x 2 1/2"	12	72	96	12,80
110-025-10007	25 x 1"	50	400	500	2,40	110-075-10059	75 x 2"	6	36	54	20,60
110-032-10011	32 x 1/2"	50	300	400	3,45	110-075-10061	75 x 2 1/2"	6	36	54	20,60
110-032-10012	32 x 3/4"	50	300	400	3,45	110-075-10063	75 x 3"	6	36	54	20,60
110-032-10013	32 x 1"	50	300	400	3,45	110-090-10075	90 x 2"	6	24	36	35,00
110-032-10014	32 x 1 1/4"	50	300	400	3,45	110-090-10077	90 x 2 1/2"	6	24	36	35,00
110-040-10021	40 x 1"	30	180	240	4,95	110-090-10079	90 x 3"	6	24	36	35,00
110-040-10022	40 x 1 1/4"	30	180	240	4,95	110-090-10083	90 x 4"	6	24	36	35,00
110-040-10023	40 x 1 1/2"	30	180	240	4,95	110-110-10091	110 x 2"	4	12	20	51,10
110-050-10032	50 x 1 1/4"	20	140	140	8,20	110-110-10093	110 x 2 1/2"	4	12	20	51,10
110-050-10033	50 x 1 1/2"	20	120	140	8,20	110-110-10095	110 x 3"	4	12	20	51,10
110-050-10035	50 x 2"	20	120	140	8,20	110-110-10099	110 x 4"	4	12	20	51,10

### KAPLİN MANŞON Pn=10 / Coupling Sleeve Pn=10

Koli Tipi **B-2**  
Çuval Tipi **S-1**

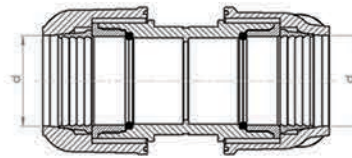

Ürün Kodu Product Code	Ürün Çapı Diameter	Ambalaj Miktarı Packing Quantity			Fiyat Price ₺	Ürün Kodu Product Code	Ürün Çapı Diameter	Ambalaj Miktarı Packing Quantity			Fiyat Price ₺
		d x d	poşet - bag	koli - box				çuval - sack	d x d	poşet - bag	
110-020-22000	20 x 20	50	450	600	2,15	110-063-22040	63 x 63	8	48	56	22,80
110-025-22004	25 x 25	50	300	350	4,30	110-075-22052	75 x 75	4	20	28	36,60
110-032-22010	32 x 32	30	180	240	6,20	110-090-22068	90 x 90	4	16	20	60,25
110-040-22018	40 x 40	20	100	140	8,75	110-110-22084	110 x 110	2	6	10	93,60
110-050-22028	50 x 50	10	70	90	14,55						

## DIŞİ KAPLIN Pn=10 / Female Coupling Pn=10

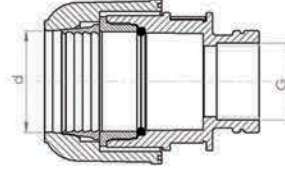
Koli Tipi **B-2**  
Çuval Tipi **S-1**

Ürün Kodu Product Code	Ürün Çapı Diameter	Ambalaj Miktarı Packing Quantity			Fiyat Price ₺
		d x G	poşet - bag	koli - box	
110-020-11001	20 x 1/2"	100	800	1000	1,30
110-020-11002	20 x 3/4"	100	800	1000	1,30
110-025-11005	25 x 1/2"	50	400	500	2,60
110-025-11006	25 x 3/4"	50	400	500	2,60
110-025-11007	25 x 1"	50	400	500	2,60
110-032-11012	32 x 3/4"	50	250	350	3,55
110-032-11013	32 x 1"	50	250	350	3,55
110-032-11014	32 x 1 1/4"	50	250	350	3,55
110-040-11021	40 x 1"	20	140	200	5,25
110-040-11022	40 x 1 1/4"	20	140	200	5,25
110-040-11023	40 x 1 1/2"	20	140	200	5,25
110-050-11032	50 x 1 1/4"	15	90	120	8,80
110-050-11033	50 x 1 1/2"	15	90	120	8,80
110-050-11035	50 x 2"	15	90	120	8,80

Ürün Kodu Product Code	Ürün Çapı Diameter	Ambalaj Miktarı Packing Quantity			Fiyat Price ₺
		d x G	poşet - bag	koli - box	
110-063-11045	63 x 1 1/2"	12	72	96	13,30
110-063-11047	63 x 2"	12	72	96	13,30
110-063-11049	63 x 2 1/2"	12	72	96	13,30
110-075-11059	75 x 2"	6	36	54	21,55
110-075-11061	75 x 2 1/2"	6	36	54	21,55
110-075-11063	75 x 3"	6	36	54	21,55
110-090-11075	90 x 2"	6	24	30	36,45
110-090-11077	90 x 2 1/2"	6	24	30	36,45
110-090-11079	90 x 3"	6	24	30	36,45
110-090-11083	90 x 4"	6	24	30	36,45
110-110-11091	110 x 2"	4	12	20	51,90
110-110-11093	110 x 2 1/2"	4	12	20	51,90
110-110-11095	110 x 3"	4	12	20	51,90
110-110-11099	110 x 4"	4	12	20	51,90

## KAPLIN REDÜKSİYON MANŞON Pn=10 / Coupling Reduction Sleeve Pn=10

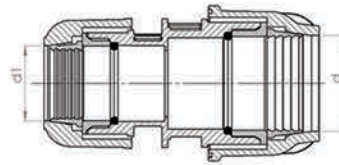
Koli Tipi **B-2**  
Çuval Tipi **S-1**

Ürün Kodu Product Code	Ürün Çapı Diameter	Ambalaj Miktarı Packing Quantity			Fiyat Price ₺
		d x d	poşet - bag	koli - box	
110-025-23004	25 x 20	50	300	400	3,30
110-032-23010	32 x 20	20	200	240	4,30
110-032-23011	32 x 25	20	200	240	5,35
110-040-23018	40 x 20	20	120	180	5,80
110-040-23019	40 x 25	20	120	180	6,75
110-040-23020	40 x 32	20	120	180	7,50
110-050-23029	50 x 25	10	80	90	10,35
110-050-23030	50 x 32	10	80	90	11,20
110-050-23031	50 x 40	10	80	90	12,15
110-063-23041	63 x 25	10	60	70	14,70

Ürün Kodu Product Code	Ürün Çapı Diameter	Ambalaj Miktarı Packing Quantity			Fiyat Price ₺
		d x d	poşet - bag	koli - box	
110-063-23042	63 x 32	10	60	70	15,50
110-063-23043	63 x 40	10	60	70	16,55
110-063-23044	63 x 50	10	50	70	19,10
110-075-23056	75 x 50	3	27	36	27,10
110-075-23057	75 x 63	3	27	36	30,70
110-090-23073	90 x 63	3	18	24	43,95
110-090-23074	90 x 75	3	18	24	49,55
110-110-23089	110 x 63	2	8	14	62,80
110-110-23090	110 x 75	2	8	14	68,60
110-110-23091	110 x 90	2	8	14	79,10

#### KAPLİN ERKEK TE Pn=10 / Coupling Male TE Pn=10

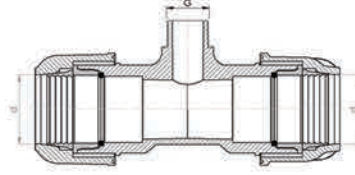

Koli Tipi **B-2**  
Çuval Tipi **S-1**

Ürün Kodu Product Code	Ürün Çapı Diameter	Ambalaj Miktarı Packing Quantity			Fiyat Price ₺	Ürün Kodu Product Code	Ürün Çapı Diameter	Ambalaj Miktarı Packing Quantity			Fiyat Price ₺
		d x G x d	poşet - bag	koli - box				çuval - sack	d x G x d	poşet - bag	
110-020-15001	20 x 1/2" x 20	30	300	360	2,60	110-050-15035	50 x 2" x 50	4	40	50	17,95
110-020-15002	20 x 3/4" x 20	30	300	360	2,60	110-063-15044	63 x 1 1/4" x 63	4	24	32	27,70
110-025-15005	25 x 1/2" x 25	20	160	200	5,15	110-063-15045	63 x 1 1/2" x 63	4	24	32	27,70
110-025-15006	25 x 3/4" x 25	20	160	200	5,15	110-063-15047	63 x 2" x 63	4	24	32	27,70
110-025-15007	25 x 1" x 25	20	160	200	5,15	110-063-15049	63 x 2 1/2" x 63	4	24	32	27,70
110-025-15008	25 x 1 1/4" x 25	20	160	200	5,15	110-075-15059	75 x 2" x 75	2	12	18	46,20
110-032-15012	32 x 3/4" x 32	20	120	140	7,25	110-075-15061	75 x 2 1/2" x 75	2	12	18	46,20
110-032-15013	32 x 1" x 32	20	120	140	7,25	110-075-15063	75 x 3" x 75	2	12	18	46,20
110-032-15014	32 x 1 1/4" x 32	20	120	140	7,25	110-090-15077	90 x 2 1/2" x 90	2	8	12	77,50
110-040-15021	40 x 1" x 40	10	60	80	10,35	110-090-15079	90 x 3" x 90	2	8	12	77,50
110-040-15022	40 x 1 1/4" x 40	10	60	80	10,35	110-090-15083	90 x 4" x 90	2	8	12	77,50
110-040-15023	40 x 1 1/2" x 40	10	60	80	10,35	110-110-15093	110x2 1/2"x110	2	4	8	114,00
110-050-15031	50 x 1" x 50	4	40	52	17,95	110-110-15095	110 x 3" x 110	2	4	8	114,00
110-050-15032	50 x 1 1/4" x 50	4	40	52	17,95	110-110-15099	110 x 4" x 110	2	4	8	114,00
110-050-15033	50 x 1 1/2" x 50	4	40	52	17,95						

#### KAPLİN TE Pn=10 / Coupling TE Pn=10

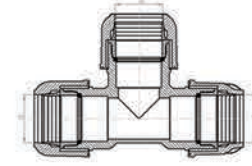

Koli Tipi **B-2**  
Çuval Tipi **S-1**

Ürün Kodu Product Code	Ürün Çapı Diameter	Ambalaj Miktarı Packing Quantity			Fiyat Price ₺	Ürün Kodu Product Code	Ürün Çapı Diameter	Ambalaj Miktarı Packing Quantity			Fiyat Price ₺
		d x d x d	poşet - bag	koli - box				çuval - sack	d x d x d	poşet - bag	
110-020-13000	20 x 20 x 20	30	240	300	3,45	110-063-13040	63 x 63 x 63	4	24	32	36,90
110-025-13004	25 x 25 x 25	20	120	180	6,80	110-075-13052	75 x 75 x 75	2	10	14	60,40
110-032-13010	32 x 32 x 32	12	72	108	9,80	110-090-13068	90 x 90 x 90	2	6	8	98,00
110-040-13018	40 x 40 x 40	10	60	80	13,75	110-110-13084	110 x 110 x 110	1	4	6	147,50
110-050-13028	50 x 50 x 50	4	40	48	23,40						

#### KAPLİN OMUZLU TE ADAPTÖR Pn=10 / Coupling Shouldered TE Adaptor Pn=10

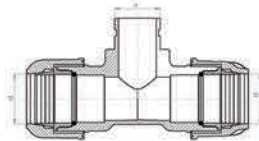

Koli Tipi **B-2**  
Çuval Tipi **S-1**

Ürün Kodu Product Code	Ürün Çapı Diameter	Ambalaj Miktarı Packing Quantity			Fiyat Price ₺
		d x G	poşet - bag	koli - box	
110-063-17047	63 x 2" x 63	4	24	32	28,00
110-110-17091	110 x 4" x 110	1	4	8	115,00

## YENİ NESİL KAPLINLER

New Generation Compression Fittings



### KAPLIN DIŞİ TE Pn=10 / Coupling Female TE Pn=10

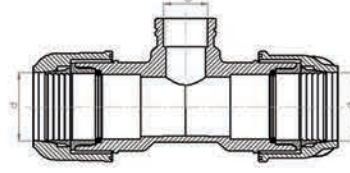

Koli Tipi **B-2**  
Çuval Tipi **S-1**

Ürün Kodu Product Code	Ürün Çapı Diameter	Ambalaj Miktarı Packing Quantity			Fiyat Price ₺	Ürün Kodu Product Code	Ürün Çapı Diameter	Ambalaj Miktarı Packing Quantity			Fiyat Price ₺
		d x G x d	poşet - bag	koli - box				çuval - sack	d x G x d	poşet - bag	
110-020-16001	20 x 1/2" x 20	30	300	360	2,65	110-050-16033	50 x 1 1/2" x 50	4	36	48	18,40
110-020-16002	20 x 3/4" x 20	30	300	360	2,65	110-050-16035	50 x 2" x 50	4	36	48	18,40
110-025-16005	25 x 1/2" x 25	20	160	200	5,15	110-063-16043	63 x 1" x 63	4	24	32	27,90
110-025-16006	25 x 3/4" x 25	20	160	200	5,15	110-063-16044	63 x 1 1/4" x 63	4	24	32	27,90
110-025-16007	25 x 1" x 25	20	160	200	5,15	110-063-16045	63 x 1 1/2" x 63	4	24	32	27,90
110-032-16011	32 x 1/2" x 32	20	100	140	7,55	110-063-16047	63 x 2" x 63	4	24	32	27,90
110-032-16012	32 x 3/4" x 32	20	100	140	7,55	110-063-16049	63 x 2 1/2" x 63	4	24	32	27,90
110-032-16013	32 x 1" x 32	20	100	140	7,55	110-075-16059	75 x 2" x 75	2	12	18	45,60
110-032-16014	32 x 1 1/4" x 32	20	100	140	7,55	110-075-16061	75 x 2 1/2" x 75	2	12	18	45,60
110-040-16020	40 x 3/4" x 40	10	60	80	11,30	110-075-16063	75 x 3" x 75	2	12	18	45,60
110-040-16021	40 x 1" x 40	10	60	80	11,30	110-090-16077	90 x 2 1/2" x 90	2	8	12	78,00
110-040-16022	40 x 1 1/4" x 40	10	60	80	11,30	110-090-16079	90 x 3" x 90	2	8	12	78,00
110-040-16023	40 x 1 1/2" x 40	10	60	80	11,30	110-090-16083	90 x 4" x 90	2	8	12	78,00
110-050-16030	50 x 3/4" x 50	4	36	48	18,40	110-110-16093	110x2 1/2"x110	1	4	8	114,20
110-050-16031	50 x 1" x 50	4	36	48	18,40	110-110-16095	110 x 3" x 110	1	4	8	114,20
110-050-16032	50 x 1 1/4" x 50	4	36	48	18,40	110-110-16099	110 x 4" x 110	1	4	8	114,20

### KAPLIN REDÜKSİYON TE Pn=10 / Coupling Reduction TE Pn=10

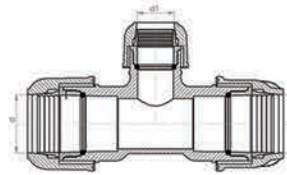

Koli Tipi **B-2**  
Çuval Tipi **S-1**

Ürün Kodu Product Code	Ürün Çapı Diameter	Ambalaj Miktarı Packing Quantity			Fiyat Price ₺	Ürün Kodu Product Code	Ürün Çapı Diameter	Ambalaj Miktarı Packing Quantity			Fiyat Price ₺
		d x d x d	poşet - bag	koli - box				çuval - sack	d x d x d	poşet - bag	
110-020-14000	20 x 25 x 20	20	200	240	4,55	110-063-14041	63 x 25 x 63	4	24	32	28,75
110-025-14004	25 x 20 x 25	20	160	200	5,80	110-063-14042	63 x 32 x 63	4	24	32	29,55
110-025-14005	25 x 32 x 25	20	120	160	7,65	110-063-14043	63 x 40 x 63	4	24	32	30,90
110-032-14010	32 x 20 x 32	10	90	120	7,85	110-063-14044	63 x 50 x 63	4	24	32	33,35
110-032-14011	32 x 25 x 32	10	80	120	8,90	110-075-14056	75 x 50 x 75	2	10	16	50,55
110-040-14019	40 x 25 x 40	10	80	90	11,60	110-075-14057	75 x 63 x 75	2	10	16	53,95
110-040-14020	40 x 32 x 40	10	60	90	12,65	110-090-14073	90 x 63 x 90	2	8	10	82,65
110-050-14029	50 x 25 x 50	4	40	48	19,20	110-090-14074	90 x 75 x 90	2	8	10	88,70
110-050-14030	50 x 32 x 50	4	40	48	20,20	110-110-14089	110 x 63 x 110	1	4	6	118,75
110-050-14031	50 x 40 x 50	4	40	48	21,20	110-110-14091	110 x 90 x 110	1	4	6	135,00

#### KAPLIN ERKEK DİRSEK Pn=10 / Coupling Male Elbow Pn=10

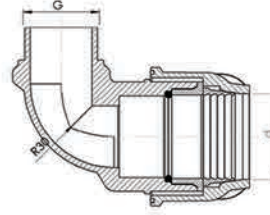

Koli Tipi **B-2**  
Çuval Tipi **S-1**

Ürün Kodu Product Code	Ürün Çapı Diameter	Ambalaj Miktarı Packing Quantity			Fiyat Price ₺	Ürün Kodu Product Code	Ürün Çapı Diameter	Ambalaj Miktarı Packing Quantity			Fiyat Price ₺
		d x G	poşet - bag	koli - box				çuval - sack	d x G	poşet - bag	
110-020-19001	20 x 1/2"	50	600	700	1,50	110-063-19045	63 x 1 1/2"	8	48	64	15,10
110-020-19002	20 x 3/4"	50	600	700	1,50	110-063-19047	63 x 2"	8	48	64	15,10
110-025-19005	25 x 1/2"	30	360	420	2,80	110-063-19049	63 x 2 1/2"	8	48	64	15,10
110-025-19006	25 x 3/4"	30	360	420	2,80	110-075-19059	75 x 2"	4	24	32	26,10
110-025-19007	25 x 1"	30	360	420	2,80	110-075-19061	75 x 2 1/2"	4	24	32	26,10
110-032-19012	32 x 3/4"	20	180	240	4,25	110-075-19063	75 x 3"	4	24	32	26,10
110-032-19013	32 x 1"	20	180	240	4,25	110-090-19077	90 x 2 1/2"	2	14	18	44,90
110-032-19014	32 x 1 1/4"	20	180	240	4,25	110-090-19079	90 x 3"	2	14	18	44,90
110-040-19021	40 x 1"	10	120	140	6,55	110-090-19083	90 x 4"	2	14	18	44,90
110-040-19022	40 x 1 1/4"	10	120	140	6,55	110-110-19095	110 x 3"	2	8	14	63,30
110-040-19023	40 x 1 1/2"	10	120	140	6,55	110-110-19099	110 x 4"	2	8	14	63,30
110-050-19032	50 x 1 1/4"	10	70	100	10,15						
110-050-19033	50 x 1 1/2"	10	70	100	10,15						
110-050-19035	50 x 2"	10	70	100	10,15						

#### KAPLIN DİRSEK Pn=10 / Coupling Elbow Pn=10

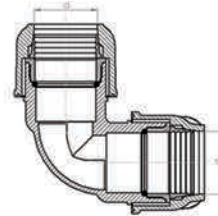

Koli Tipi **B-2**  
Çuval Tipi **S-1**

Ürün Kodu Product Code	Ürün Çapı Diameter	Ambalaj Miktarı Packing Quantity			Fiyat Price ₺	Ürün Kodu Product Code	Ürün Çapı Diameter	Ambalaj Miktarı Packing Quantity			Fiyat Price ₺
		d x d	poşet - bag	koli - box				çuval - sack	d x d	poşet - bag	
110-020-18000	20 x 20	50	400	600	2,30	110-063-18040	63 x 63	8	32	48	24,85
110-025-18004	25 x 25	30	210	270	4,50	110-075-18052	75 x 75	4	16	24	40,75
110-032-18010	32 x 32	20	140	180	6,50	110-090-18068	90 x 90	2	10	16	65,30
110-040-18018	40 x 40	12	72	108	9,35	110-110-18084	110 x 110	1	6	10	98,95
110-050-18028	50 x 50	8	48	64	15,50						



## KAPLIN DIŞİ DİRSEK Pn=10 / Coupling Female Elbow Pn=10

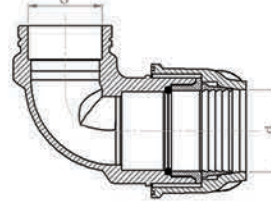

Koli Tipi **B-2**  
Çuval Tipi **S-1**

Ürün Kodu Product Code	Ürün Çapı Diameter	Ambalaj Miktarı Packing Quantity			Fiyat ₺ Price	Ürün Kodu Product Code	Ürün Çapı Diameter	Ambalaj Miktarı Packing Quantity			Fiyat ₺ Price
		d x G	poşet - bag	koli - box				çuval - sack	d x G	poşet - bag	
110-020-20001	20 x 1/2"	50	600	700	1,55	110-063-20045	63 x 1 1/2"	8	48	64	15,20
110-020-20002	20 x 3/4"	50	500	700	1,55	110-063-20047	63 x 2"	8	48	64	15,20
110-025-20005	25 x 1/2"	30	300	420	2,90	110-063-20049	63 x 2 1/2"	8	48	64	15,20
110-025-20006	25 x 3/4"	30	300	420	2,90	110-075-20059	75 x 2"	4	24	32	28,20
110-025-20007	25 x 1"	30	300	420	2,90	110-075-20061	75 x 2 1/2"	4	24	32	28,20
110-032-20012	32 x 3/4"	20	180	240	4,40	110-075-20063	75 x 3"	4	24	32	28,20
110-032-20013	32 x 1"	20	180	240	4,40	110-090-20077	90 x 2 1/2"	2	14	18	45,50
110-032-20014	32 x 1 1/4"	20	180	240	4,40	110-090-20079	90 x 3"	2	14	18	45,50
110-040-20021	40 x 1"	10	120	140	6,65	110-090-20083	90 x 4"	2	14	18	45,50
110-040-20022	40 x 1 1/4"	10	120	140	6,65	110-110-20095	110 x 3"	2	8	14	65,50
110-040-20023	40 x 1 1/2"	10	120	140	6,65	110-110-20099	110 x 4"	2	8	14	65,50
110-050-20032	50 x 1 1/4"	10	70	100	10,65						
110-050-20033	50 x 1 1/2"	10	70	100	10,65						
110-050-20035	50 x 2"	10	70	100	10,65						

## KAPLIN REDÜKSİYON DİRSEK Pn=10 / Coupling Reduction Elbow Pn=10

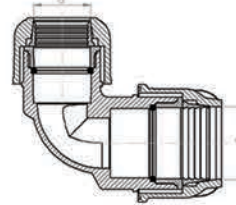

Koli Tipi **B-2**  
Çuval Tipi **S-1**

Ürün Kodu Product Code	Ürün Çapı Diameter	Ambalaj Miktarı Packing Quantity			Fiyat ₺ Price	Ürün Kodu Product Code	Ürün Çapı Diameter	Ambalaj Miktarı Packing Quantity			Fiyat ₺ Price
		d x d	poşet - bag	koli - box				çuval - sack	d x d	poşet - bag	
110-025-21004	25 x 20	30	300	360	3,45	110-063-21044	63 x 50	8	40	56	20,00
110-032-21011	32 x 25	20	160	200	5,60	110-075-21057	75 x 63	4	24	32	32,50
110-040-21020	40 x 32	10	90	120	7,95	110-090-21074	90 x 75	2	10	16	56,30
110-050-21031	50 x 40	8	64	80	12,60	110-110-21091	110 x 90	2	8	12	85,10

### KAPLIN OMUZLU ADAPTÖR Pn=10 / Coupling Shouldered Adaptor Pn=10

Koli Tipi **B-2**  
Çuval Tipi **S-1**

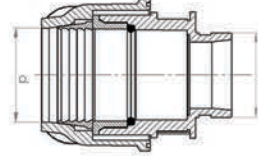

Ürün Kodu Product Code	Ürün Çapı Diameter	Ambalaj Miktarı Packing Quantity			Fiyat Price ₺	Ürün Kodu Product Code	Ürün Çapı Diameter	Ambalaj Miktarı Packing Quantity			Fiyat Price ₺
		poşet - bag	koli - box	çuval - sack				poşet - bag	koli - box	çuval - sack	
110-063-12047	63 x 2"	12	72	96	13,00	110-110-12099	110 x 4"	4	12	20	52,00

### KAPLIN KÖRTAPA Pn=10 / Coupling End Cap Pn=10

Koli Tipi **B-2**  
Çuval Tipi **S-1**

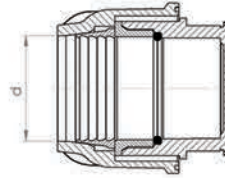

Ürün Kodu Product Code	Ürün Çapı Diameter	Ambalaj Miktarı Packing Quantity			Fiyat Price ₺	Ürün Kodu Product Code	Ürün Çapı Diameter	Ambalaj Miktarı Packing Quantity			Fiyat Price ₺
		d	poşet - bag	koli - box				çuval - sack	d	poşet - bag	
110-020-24000	20	100	1.000	1100	1,15	110-063-24040	63	12	72	96	12,60
110-025-24004	25	50	500	600	2,25	110-075-24052	75	6	36	54	20,20
110-032-24010	32	50	300	400	3,25	110-090-24068	90	6	24	36	32,90
110-040-24018	40	30	180	270	4,60	110-110-24084	110	4	12	20	49,60
110-050-24028	50	16	112	144	8,00						

### KAPLIN ANAHTAR / Coupling Wrench

Koli Tipi **B-2**



Ürün Kodu Product Code	Ürün Çapı Diameter	Ambalaj Miktarı Packing Quantity			Fiyat Price ₺
		mm	poşet - bag	koli - box	
010-000-25000	20 - 25 - 32	5	150	-	3,65
010-000-25001	40 - 50 - 63 - 75	5	75	-	11,35
010-000-25002	90 - 110	5	40	-	21,40

# AYAS

tarımsal sulama ekipmanları

## Priz Kolyeler

Clamp Saddles



Erhas Priz Kolyeler pazardaki mevcut ürünlerin kullanımında yaşanan eksiklikler göz önüne alınarak firmamız tarafından ürün üzerinde geliştirmeler yapılmış olup son kullanıcı tarafından arazi şartlarında rahatlıkla uygulanabilir şekilde dizayn edilmiştir. Gövdesinde yapılan kuvvetlendirmeler ve o-ring sistemi sayesinde mükemmel sızdırmazlık sağlamaktadır. Ø 63 - Ø 200 mm aralığında kullanıcı talebine göre metal yüklü modellerimizde mevcuttur. Ağır arazi şartlarında çalışmayı kolaylaştırmak amacıyla civata deliklerinde civataların ters pozisyonda düşmesini engellemek için Civata Tutucu Tırnak Sistemi geliştirilmiştir. Montaj edilmiş priz kolyenin boru üzerinde sabit durması için iç yüzeyde sıkma dişleri yerleştirilmiştir.

*\*Civata Tutucu Tırnak Sistemi ve Boru Sabitleyici Sıkma Dişleri üretim tekniği bakımından yalnızca tek çıkışlı priz kolyelerde mevcuttur.\**

Erhas Clamp Saddles are designed by making improvements for easy usage of the last user while considering the lack in the features of the products available in the market. It provides excellent leakproof by the help of strengthening has been made on its body and o-ring system. Metal ring models are also available in case of customer requests in Ø 63 - 200 mm range. In order to ease working in the difficult field conditions Bolt Holder Nail System has been improved to prevent the fall of the bolts when they are in upsidedown position. Tightening bumps have been located on the inside surface for the purpose of fixing the pipe's rotation.

*\*Bolt Holder Nail System and Pipe Fixing Tightening Bumps are only available in single outlet clamp saddles concerning their manufacturing technics.\**



**Civata Tutucu Tırnak Sistemi**

*Bolt holder nail system*

**Boru Sabitleyici Sıkma Dişleri**

*Pipe fixing tightening bumps*

#### Kullanım Bilgileri

- Priz kolyelerde oring, yuvasına düzgünce oturtulmalı ve montaj esnasında yerinden çıkmamasına özen gösterilmelidir.
- Priz kolye ile kullanılacak erkek adaptörlere teflon bant sızdırmazlığı sağlayacak kadar ve sıkma yönüyle aynı yönde sarılmalıdır.
- Priz kolyelerin montajı yapıldıktan sonra yapılan boruyu delme işlemi Priz Kolyenin dişli kısmının bozulmasına neden olabilir. Bu nedenle küçük çaplı bir matkap ucu ile dişlere değmeyecek şekilde delme işlemi gerçekleştirilmelidir.
- Priz kolyelerde sızdırmazlığı sağlayacak kadar kamalar çakılmalı ve civatalar sıkılmalıdır.
- Boruda ölçü farklılığı var ise ve ölçü standart değerinden büyük ise (> 0.5 mm) priz kolye montajında alt ve üst kapaklar birbirine değmeyecektir. Bu durumda; civatalı priz kolyelerin civatalarının alt ve üst kapaklar birbirine değene kadar sıkılmasına, geçmeli priz kolyelerin de kamalarının sonuna kadar çakılmasına gerek yoktur. Aksi halde ürün üzerinde aşırı gerilme meydana gelecektir. Bu durum tesisatınızın ömrünü etkileyeceği gibi ürünün ölçülerinin de değişmesine neden olabilir. Özellikle dişli kısımdaki ölçü değişimi priz kolyeye monte edilecek olan erkek dişli adaptörün montajını engelleyebilir.
- Priz kolyelerin montajı sırasında kamalar ve civatalar karşılıklı monte edilmelidir. Önce bir kamanın tamamen çakılması veya bir civatanın tamamen sıkılması sonucu malzemenin bir tarafında aşırı bir kuvvet oluşur ve bu kuvvet kırılmaya neden olabilir.

#### Usage Information

- The oring should be placed in its socket carefully in order not to be unsettled during the installation.
- Male adaptors should be wrapped up with the teflon band with the wrenching direction and should be wrapped enough to prevent leakage.
- The process of drilling the pipe after the installation of clamp saddle may damage the threaded part. For this reason, the drilling should be implemented with a rather smaller dimensioned drill without contacting the threads.
- Cotters should be hammered or the bolts should be wrenching in order to prevent leakage in the clamp saddles.
- If the dimension of the installed pipe is bigger than the standard values, upper and lower body parts will not contact each other. Under these circumstances, there is no need to wrench the bolts till the upper and lower body parts contact or hammer the cotters to the end point. Otherwise an extra tension will be occurred over the product. This situation may have negative effect on the lifetime of your system as it might cause changes on the dimensions of the product. The dimensional differences especially on the threaded parts might block the installation of the male threaded adaptor.
- During the installation of the clamp saddles, the cotters and the bolts should be installed equally. Complete hammering a cotter or completely wrenching the bolts in one side of the saddle may cause an excessive force which might cause a break on the product.

## TEK ÇIKIŞLI PRİZ KOLYE / Single Outlet Clamp Saddle

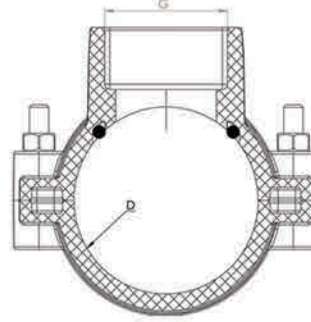
Koli Tipi **B-2**  
Çuval Tipi **S-1**

Ürün Kodu Product Code	Ebatlar Dimensions	Ambalaj Miktarı Packing Quantity		Fiyat Price ₺
		D x G	çuval - sack	
010-025-50005	25 x 1/2"	600	400	3,10
010-032-50011	32 x 1/2"	500	350	3,25
010-032-50012	32 x 3/4"	500	350	3,25
010-040-50019	40 x 1/2"	400	250	5,00
010-040-50020	40 x 3/4"	400	250	5,00
010-050-50029	50 x 1/2"	200	180	8,00
010-050-50030	50 x 3/4"	200	180	8,00
010-050-50031	50 x 1"	200	180	8,50
010-063-50041	63 x 1/2"	200	150	9,35
010-063-50042	63 x 3/4"	200	150	9,35
010-063-50043	63 x 1"	200	150	9,85
010-063-50044	63 x 1 1/4"	200	150	10,25
010-063-50045	63 x 1 1/2"	200	150	10,70
010-075-50053	75 x 1/2"	150	100	10,25
010-075-50054	75 x 3/4"	150	100	10,35
010-075-50055	75 x 1"	150	100	10,90
010-075-50056	75 x 1 1/4"	150	100	11,35
010-075-50057	75 x 1 1/2"	150	100	11,85
010-075-50059	75 x 2"	150	100	12,55
010-090-50069	90 x 1/2"	100	75	12,10
010-090-50070	90 x 3/4"	100	75	12,10
010-090-50071	90 x 1"	100	75	12,95
010-090-50072	90 x 1 1/4"	100	75	12,95
010-090-50073	90 x 1 1/2"	100	75	13,30
010-090-50075	90 x 2"	100	75	14,25

Ürün Kodu Product Code	Ebatlar Dimensions	Ambalaj Miktarı Packing Quantity		Fiyat Price ₺
		D x G	çuval - sack	
010-110-50085	110 x 1/2"	100	60	14,00
010-110-50086	110 x 3/4"	100	60	14,00
010-110-50087	110 x 1"	100	60	14,60
010-110-50088	110 x 1 1/4"	100	60	14,85
010-110-50089	110 x 1 1/2"	100	60	15,30
010-110-50091	110 x 2"	100	60	16,10
010-125-50102	125 x 3/4"	75	45	13,90
010-125-50103	125 x 1"	75	45	14,35
010-125-50104	125 x 1 1/4"	75	45	14,65
010-125-50105	125 x 1 1/2"	75	45	15,10
010-125-50107	125 x 2"	75	45	16,10
010-140-50118	140 x 3/4"	50	40	15,20
010-140-50119	140 x 1"	50	40	15,70
010-140-50120	140 x 1 1/4"	50	40	15,90
010-140-50121	140 x 1 1/2"	50	40	16,35
010-140-50123	140 x 2"	50	40	17,15
010-160-50134	160 x 3/4"	50	40	17,65
010-160-50135	160 x 1"	50	40	18,15
010-160-50136	160 x 1 1/4"	50	40	18,35
010-160-50137	160 x 1 1/2"	50	40	18,80
010-160-50139	160 x 2"	50	40	19,65
010-200-50150	200 x 3/4"	40	30	20,20
010-200-50151	200 x 1"	40	30	21,00
010-200-50152	200 x 1 1/4"	40	30	21,00
010-200-50153	200 x 1 1/2"	40	30	21,70
010-200-50155	200 x 2"	40	30	22,35

### ÇİFT ÇIKIŞLI PRİZ KOLYE / Double Outlet Clamp Saddle

Koli Tipi **B-2**  
Çuval Tipi **S-1**

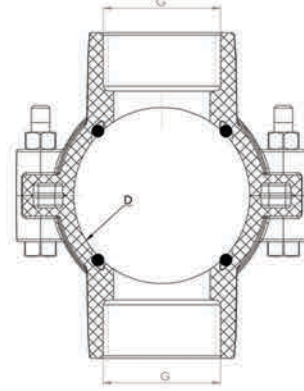

Ürün Kodu Product Code	Ebatlar Dimensions	Ambalaj Miktarı Packing Quantity		Fiyat Price ₺
		çuval - sack	koli - box	
010-025-55005	25 x 1/2" x 1/2"	600	400	3,80
010-032-55011	32 x 1/2" x 1/2"	500	350	3,90
010-032-55012	32 x 3/4" x 3/4"	500	350	3,90
010-040-55019	40 x 1/2" x 1/2"	400	250	5,75
010-040-55020	40 x 3/4" x 3/4"	400	250	5,75
010-050-55029	50 x 1/2" x 1/2"	200	180	8,85
010-050-55030	50 x 3/4" x 3/4"	200	180	8,85
010-050-55031	50 x 1" x 1"	200	180	9,90
010-063-55041	63 x 1/2" x 1/2"	200	150	10,30
010-063-55042	63 x 3/4" x 3/4"	200	150	10,30
010-063-55043	63 x 1" x 1"	200	150	11,25
010-063-55044	63 x 1 1/4" x 1 1/4"	200	150	12,10
010-063-55045	63 x 1 1/2" x 1 1/2"	200	150	13,00
010-075-55053	75 x 1/2" x 1/2"	150	100	11,00
010-075-55054	75 x 3/4" x 3/4"	150	100	11,15
010-075-55055	75 x 1" x 1"	150	100	12,30
010-075-55056	75 x 1 1/4" x 1 1/4"	150	100	13,15
010-075-55057	75 x 1 1/2" x 1 1/2"	150	100	14,20
010-075-55059	75 x 2" x 2"	150	100	15,60
010-090-55069	90 x 1/2" x 1/2"	100	75	13,20
010-090-55070	90 x 3/4" x 3/4"	100	75	13,20
010-090-55071	90 x 1" x 1"	100	75	14,65
010-090-55072	90 x 1 1/4" x 1 1/4"	100	75	14,90
010-090-55073	90 x 1 1/2" x 1 1/2"	100	75	15,65
010-090-55075	90 x 2" x 2"	100	75	17,55



Ürün Kodu Product Code	Ebatlar Dimensions	Ambalaj Miktarı Packing Quantity		Fiyat Price ₺
		çuval - sack	koli - box	
010-110-55085	110 x 1/2" x 1/2"	100	60	14,10
010-110-55086	110 x 3/4" x 3/4"	100	60	14,10
010-110-55087	110 x 1" x 1"	100	60	15,30
010-110-55088	110 x 1 1/4" x 1 1/4"	100	60	15,80
010-110-55089	110 x 1 1/2" x 1 1/2"	100	60	16,70
010-110-55091	110 x 2" x 2"	100	60	18,30
010-125-55102	125 x 3/4" x 3/4"	75	45	14,65
010-125-55103	125 x 1" x 1"	75	45	15,70
010-125-55104	125 x 1 1/4" x 1 1/4"	75	45	16,25
010-125-55105	125 x 1 1/2" x 1 1/2"	75	45	17,20
010-125-55107	125 x 2" x 2"	75	45	19,20
010-140-55118	140 x 3/4" x 3/4"	50	40	16,10
010-140-55119	140 x 1" x 1"	50	40	17,20
010-140-55120	140 x 1 1/4" x 1 1/4"	50	40	17,60
010-140-55121	140 x 1 1/2" x 1 1/2"	50	40	18,45
010-140-55123	140 x 2" x 2"	50	40	20,05
010-160-55134	160 x 3/4" x 3/4"	50	40	18,40
010-160-55135	160 x 1" x 1"	50	40	19,35
010-160-55136	160 x 1 1/4" x 1 1/4"	50	40	19,75
010-160-55137	160 x 1 1/2" x 1 1/2"	50	40	20,65
010-160-55139	160 x 2" x 2"	50	40	22,40
010-200-55150	200 x 3/4" x 3/4"	40	30	21,00
010-200-55151	200 x 1" x 1"	40	30	22,30
010-200-55152	200 x 1 1/4" x 1 1/4"	40	30	22,50
010-200-55153	200 x 1 1/2" x 1 1/2"	40	30	24,00
010-200-55155	200 x 2" x 2"	40	30	25,30

## YÜKLEME DETAYLARI

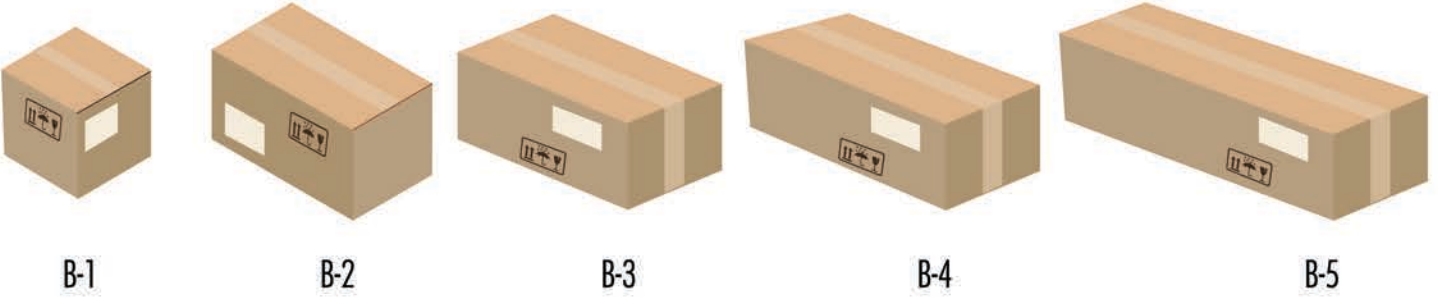

Loading Details

### AMBALAJ EBATLARI / Packing Dimensions



Ambalaj Tipi Packing Type	En Width	Boy Length	Yükseklik Height	
	cm	cm	cm	
	B-1	33	45	38
	B-2	46	65	44
	B-3	35	75	25
	B-4	35	95,5	25
	B-5	35	122	25
	S-1	55	105	30
	S-2	25	70	22
	S-3	35	80	22
	S-4	50	80	22

### YÜKLEME ADETLERİ / Loading Quantities

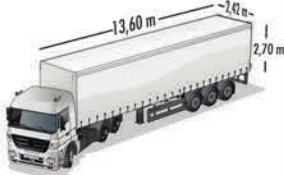
Ambalaj Tipi Packing Type	 20" DC	 40" DC	 40" HC	 TRUCK
B-1	516	1056	1232	1470
B-2	225	450	540	630
B-3	450	920	1020	1170
B-4	348	730	800	924
B-5	256	548	600	715
S-1	210	420	470	520
S-2	750	1530	1836	2080
S-3	480	975	1170	1330
S-4	345	675	810	920

**ERHAS**<sup>®</sup>  
IRRIGATION SYSTEMS

**ASBİR**<sup>®</sup>  
TARIMSAL SULAMA EKIPMANLARI

Türkiye Genel Dağıtıcısı

**AYAS**

**tarımsal sulama ekipmanları**

**AYAS SULAMA SİSTEMLERİ LTD. ŞTİ.**

Fevzi Çakmak Mahallesi Büsan Sanayi Sitesi 10670 Sokak 29F

Karatay / KONYA / TÜRKİYE

**Tel.** +90.332 502 0 555 • **Fax.** +90.332 502 0 510

[www.ayassulama.com](http://www.ayassulama.com) - [info@ayassulama.com](mailto:info@ayassulama.com)

